

**Huber**  
AQUA EMOTIONS

Huber

NUOVA EGO





# Aqua Emotions



## ***The company***

*Fifty years of know-how in technology and manufacturing, focused on the most complex and sophisticated brassware product, the thermostatic mixer. These are the essential interpretative keys to HUBER, one of the leading manufacturers in Europe and by far the Italian leader in this industry.*

*From the beginning back in the mid Sixties with the Thetamix milestone, through the innovations made since 1987, the case history quickly unfolds with the design and manufacture of the first modern bathroom thermostatics with design and features suited to contemporary needs. Quickly becoming an important industrial business, HUBER has always believed in the total control of the product and its manufacturing process, which is fully integrated into its facilities.*

*A strong and skilled team of engineers, researchers and designers is dedicated to the continuous development of technology and design.*

## **L'azienda**

Cinquant'anni di know-how tecnologico e produttivo, incentrato sul prodotto di rubinetteria più complesso e sofisticato, il termostatico. Queste le prime chiavi interpretative di HUBER, tra i principali produttori in Europa e leader italiano indiscusso di questo settore.

Dagli esordi della metà degli anni Sessanta con il glorioso Thetamix, attraverso le innovazioni impresse a partire dal 1987, la case history si snoda rapidamente con la progettazione e fabbricazione dei primi veri termostatici da sala bagno con design e caratteristiche adatte alle esigenze contemporanee.

Divenuta rapidamente una realtà industriale importante, HUBER ha sempre creduto nel controllo totale del prodotto e del processo di fabbricazione, interamente integrato nei propri stabilimenti.

Per lo sviluppo continuo della tecnologia e del design è attivo all'interno dell'azienda un forte e competente team di tecnici, ricercatori e progettisti.



## Huber lab

*In the aim of developing the objectives inherent to the spirit of the brand, HuberLab has born: a laboratory of creative interaction in which a team of engineers and creatives combines the experience on technologies and functionality with creativity and stylistic research, for an innovative approach to industrial design.*

*“Propose new scenarios, with the aim to excite through contemporary objects of high precision and strong identity: smart and efficient products, careful to ensure everyone a safe and easy access to the water resource, while respecting the planet.”*

Per sviluppare gli obiettivi connotati allo spirito dell'azienda, è nato HuberLab, un laboratorio di interazione creativa nel quale un variegato team di tecnici e di creativi combina l'esperienza sulle tecnologie e la funzionalità alla creatività e alla ricerca stilistica, per un approccio innovativo al design industriale.

“Proporre nuovi scenari, con l'obiettivo di emozionare attraverso oggetti contemporanei di alta precisione e con una forte identità: prodotti smart ed efficienti, attenti a garantire a tutti un accesso sicuro e facile alla risorsa acqua, nel rispetto del pianeta.”





## Responsibility.

*Water is the key element for human beings and for the planet: conserving water resources and promoting responsible water use is essential for all of us.*

*HUBER has always been committed to this, with the continuous development of water-efficient products which, besides controlling it, can save as much water as possible in daily use: thermostatics. We strongly believe it is our responsibility to serve as stewards of the planet's resources and to actively contribute to environmental protection with our water-related business. All our manufacturing processes are designed and carried out so that water is conserved and protected. The temperature calibration and chrome plating processes are based on continuous recirculation water cycles, ensuring maximum efficiency and conservation of resources and which exceed the strict Italian and European environmental regulations and standards. Our plating plant operates within the "AIA" highest existing level of environmental compliance framework.*

## Responsabilità.

L'acqua è l'elemento fondamentale per l'essere umano e per il pianeta: tutelare le risorse d'acqua e promuoverne l'uso responsabile è essenziale per tutti noi. HUBER da sempre ha fatto di questo impegno la propria missione, con lo sviluppo continuo di prodotti efficienti che permettono, oltre al suo controllo, anche il maggior risparmio possibile d'acqua nell'uso quotidiano: i termostatici.

Noi crediamo fermamente che sia nostra responsabilità metterci al servizio delle risorse del pianeta e contribuire attivamente alla protezione dell'ambiente nell'ambito del nostro business legato all'acqua. Tutti i nostri processi produttivi sono concepiti e operati in modo che l'acqua sia conservata e protetta. Le operazioni di taratura in temperatura e di cromatura sono basate su processi a riciclo permanente che assicurano la massima efficienza e conservazione nell'uso delle risorse, eccedendo i requisiti dei severi standards previsti dalle normative italiane ed europee.

Il nostro impianto di rivestimento galvanico opera nel quadro del più elevato grado di certificazione ambientale "AIA".



**Certified  
Industrial  
Water  
Efficiency**



**NE 54**  
Monocomando Lavabo  
Basin Mixer



# Nuova Ego

*Sharp lines, defined mirror planes for a bold, unequivocal urban statement: this is NUOVA EGO.*

*NUOVA EGO embodies uncompromised geometrical, modern design with its essential, clear system of cutting-edge lines and light-reflecting surfaces.*

*NUOVA EGO: resolute metropolitan accent.*

Linee precise, definiti piani a specchio per un forte, inequivocabile carattere urbano: questo è NUOVA EGO.

NUOVA EGO esprime il design geometrico moderno senza compromessi con il suo chiaro, essenziale sistema di linee a spigolo vivo e superfici riflettenti.

NUOVA EGO: risoluto accento metropolitano.

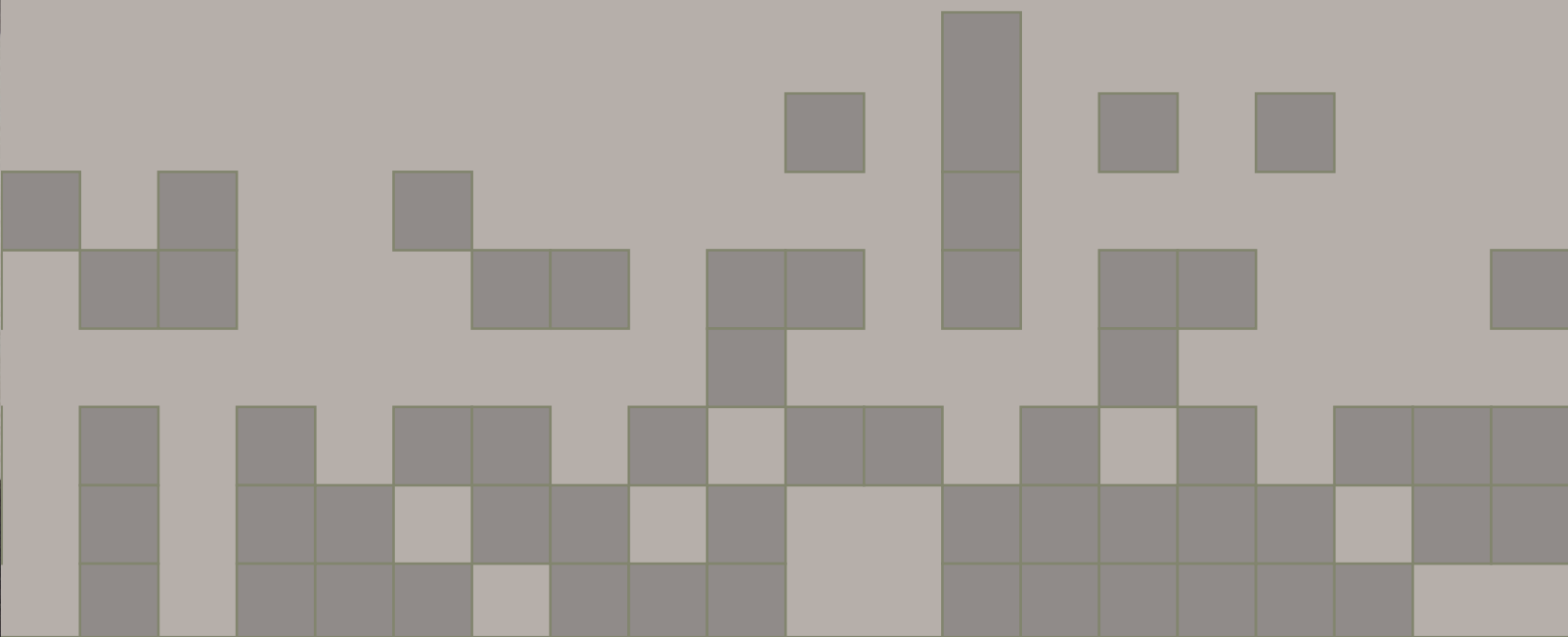







**NE 51**  
Monocomando Lavabo  
Basin Mixer





**NE 354**  
Monocomando Lavabo  
Basin Mixer

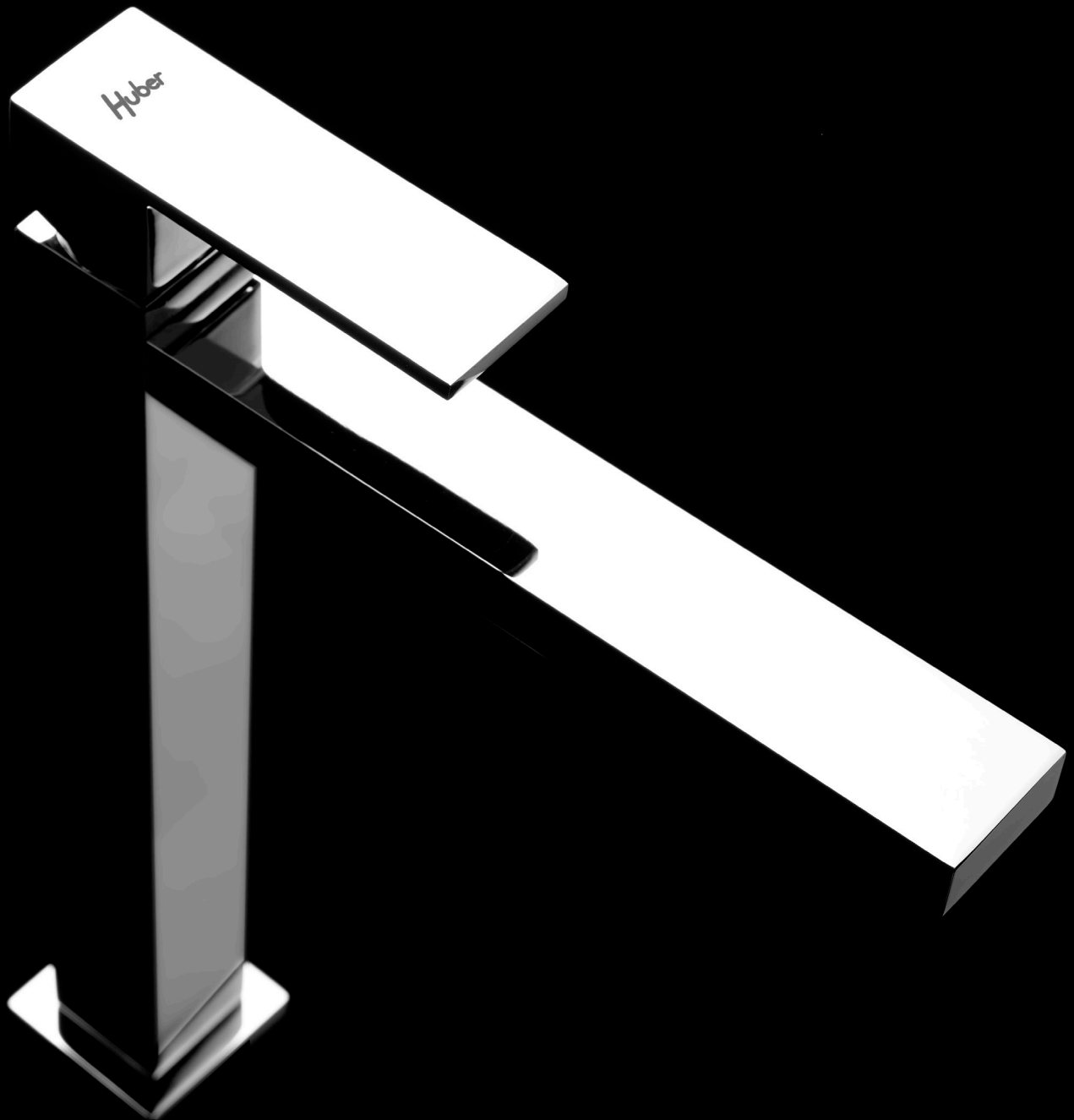





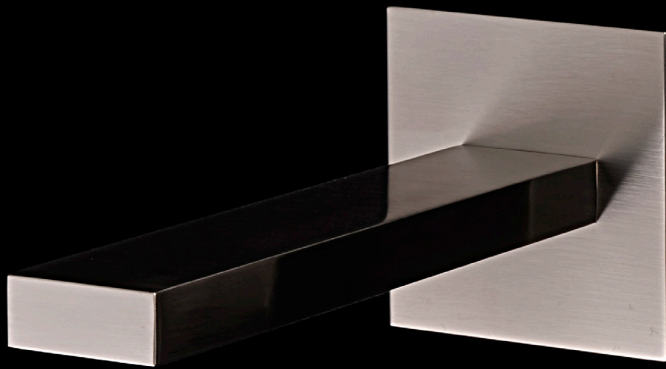

**NE 551**  
Monocomando Lavabo  
Basin Mixer





**NE C86**  
CombiDoccia Termostatica  
Thermo CombiShower



Huber

OFF

ON

**NE 1810**

Termostatico 2 Uscite  
2-Outlet Thermo



**NE 210**  
Monocomando Vasca/Doccia  
Bath/S. Mixer



**NE 1V200**  
Termostatico 2 Funzioni  
2-Function Thermo

NUOVA EGO

*Products  
and  
Accessories*

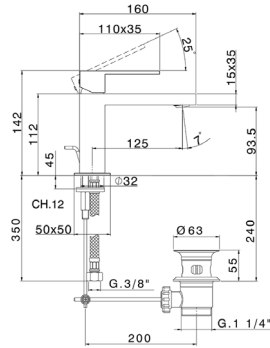
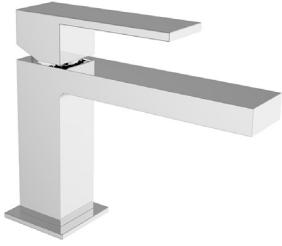

**NE 000514**  
 Monocomando Lavabo  
 Basin Mixer  
 Mitigeur Lavabo

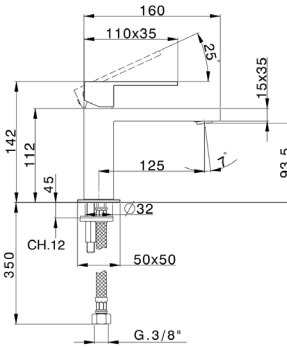
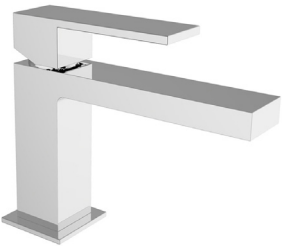

**NE 000544**  
 Monocomando Lavabo  
 Basin Mixer  
 Mitigeur Lavabo

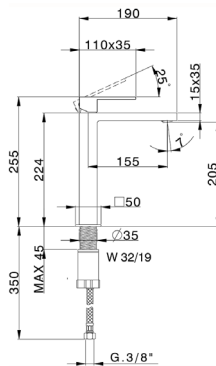

**NE 003544**  
 Monocomando Lavabo  
 Basin Mixer  
 Mitigeur Lavabo

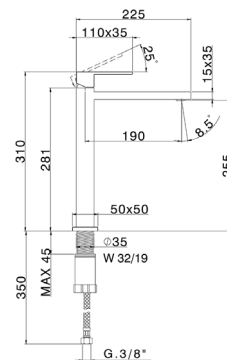

**NE 004544**  
 Monocomando Lavabo  
 Basin Mixer  
 Mitigeur Lavabo



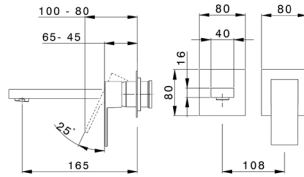
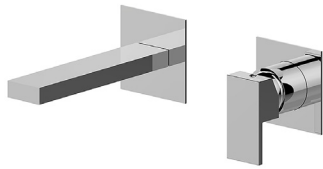

### NE 005510

Parte Esterna Monocomando Lavabo  
 Basin Mixer Exposed Part  
 Partie Apparente Mitigeur Lavabo

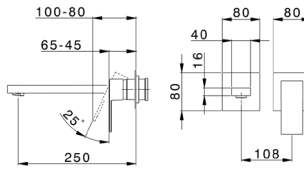
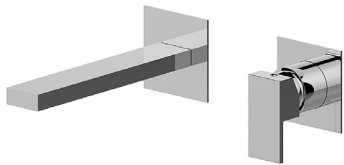

### NE 005511

Parte Esterna Monocomando Lavabo  
 Basin Mixer Exposed Part  
 Partie Apparente Mitigeur Lavabo

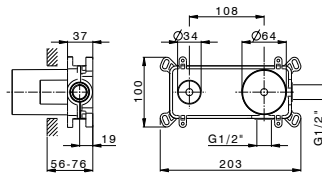

### ZB 002450

Parte Incasso Monocomando Lavabo  
 Basin Mixer Concealed Part  
 Partie Apparente Mitigeur Lavabo

EasyBox

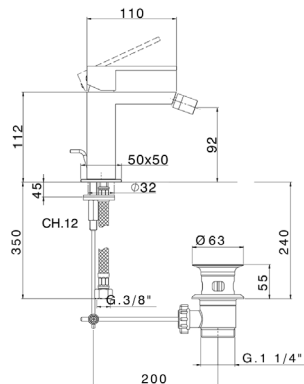

### NE 000554

Monocomando Bidet  
 Bidet Mixer  
 Mitigeur Bidet

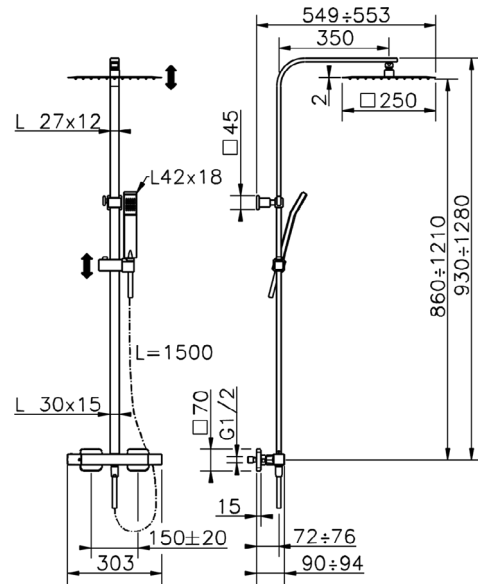

**QT C8602H**  
 CombiDoccia Termostatico  
 Thermo CombiShower  
 CombiDouche Thermo

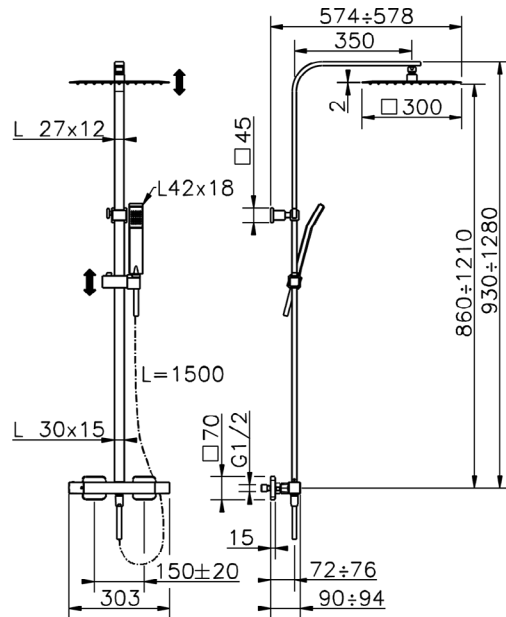

**QT C8603H**  
 CombiDoccia Termostatico  
 Thermo CombiShower  
 CombiDouche Thermo



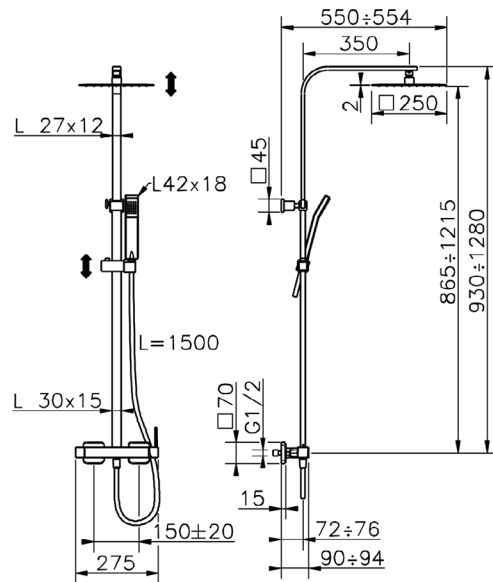

**QT 0R4031**  
 CombiDoccia Monocomando  
 CombiShower Mixer  
 CombiDouche Mitigeur

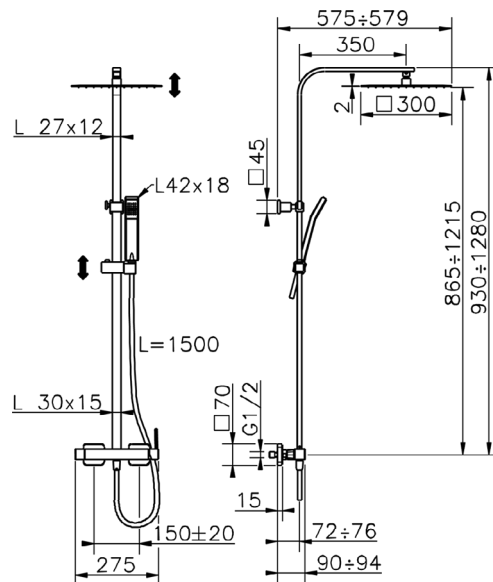

**QT 0R4032**  
 CombiDoccia Monocomando  
 CombiShower Mixer  
 CombiDouche Mitigeur



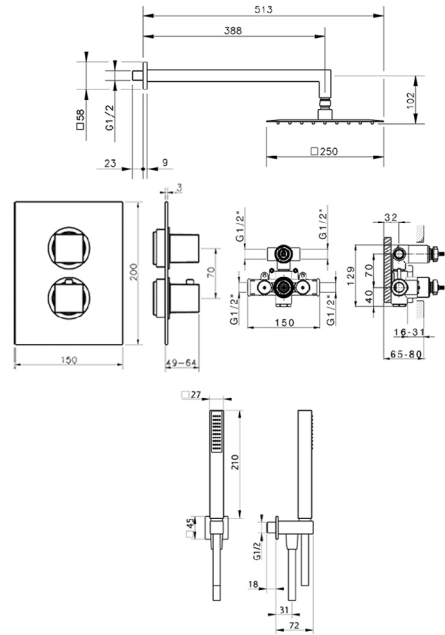

**NE OKT010**

Completo Termostatico Doccia 2 Funzioni  
 2-Function Thermo Shower Set  
 Ensemble Thermo Douche 2 Fonctions

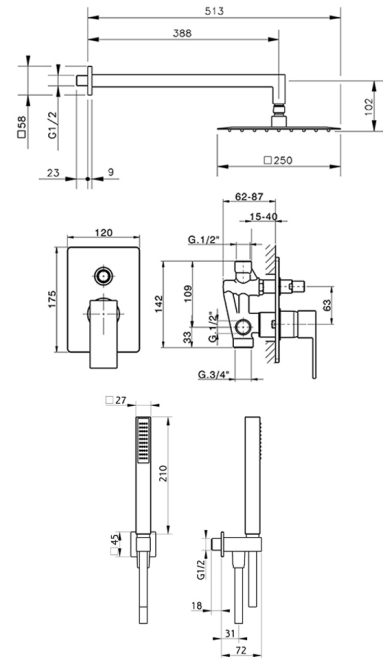

**NE OKM010**

Completo Monocomando Doccia 2 Funzioni  
 2-Function Mixer Shower Set  
 Ensemble Mitigeur Douche 2 Fonctions

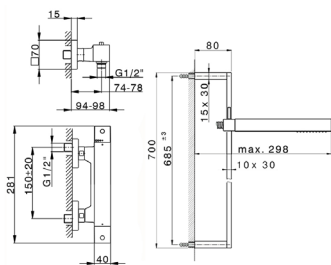

**NE S01010**  
 Completo Termostatico Doccia  
 Thermo Shower Set  
 Ensemble Thermo Douche

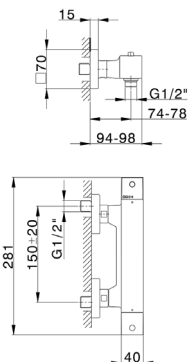
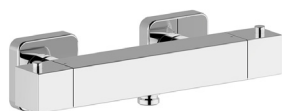

**NE T01010**  
 Termostatico Doccia  
 Shower Thermo  
 Thermo Douche

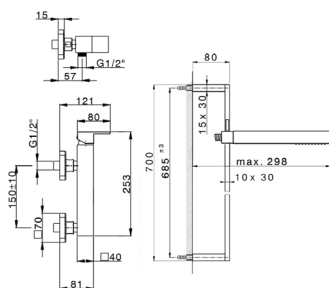

**NE 000464**  
 Completo Monocomando Doccia  
 Shower Mixer Set  
 Ensemble Mitigeur Douche

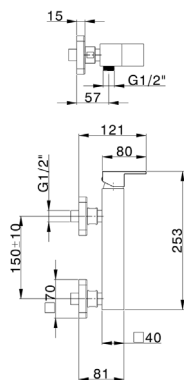

**NE 000444**  
 Monocomando Doccia  
 Shower Mixer  
 Mitigeur Douche

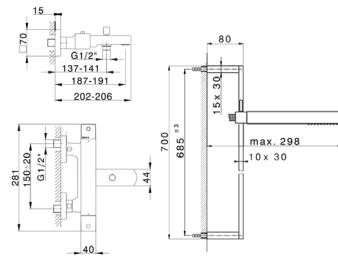

**NE S27010**  
 Completo Termostatico Vasca  
 Thermo Bath/S. Set  
 Ensemble Thermo Bain/D.

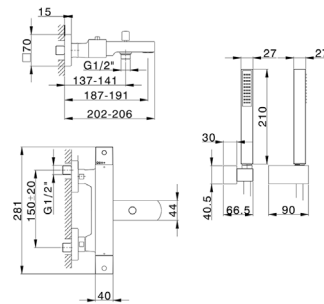

**NE D27010**  
 Completo Termostatico Vasca  
 Thermo Bath/S. Set  
 Ensemble Thermo Bain/D.

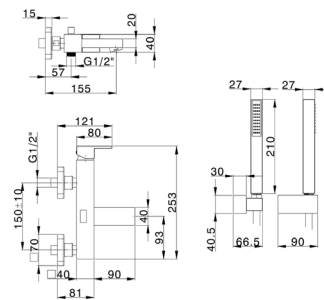

**NE 000124**  
 Completo Monocomando Vasca  
 Bath/S. Mixer Set  
 Ensemble Mitigeur Bain/D.

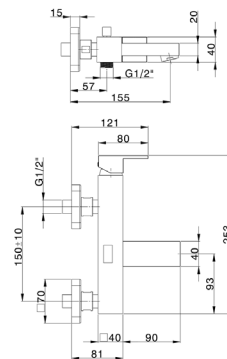

**NE 000134**  
 Monocomando Vasca  
 Bath/S. Mixer  
 Mitigeur Bain/D.

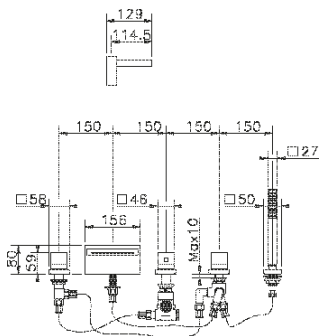
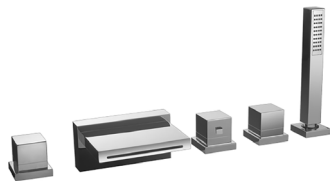

### NE T77010

Batteria Termostatico bordo Vasca  
Thermo Deck Mounted Bath Set  
Ensemble Bain/D. Thermo sur Gorge

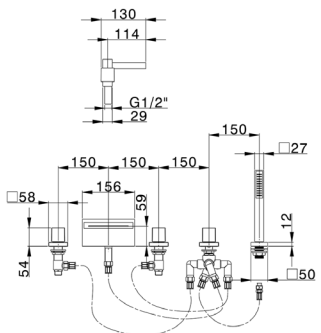
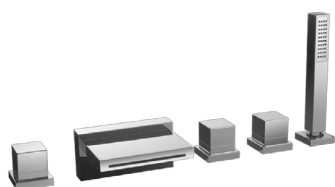

### NE 000260

Batteria Bordo Vasca  
Deck Mounted Bath Set  
Ensemble Bain/D. sur Gorge

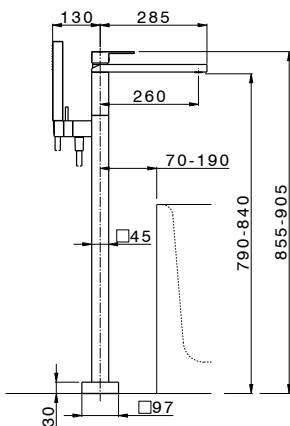

### NE 014200

Parte Esterna Monocomando Vasca Free-Standing  
Free-Standing Bath/S. Mixer Exposed Part  
Partie Apparente Mitigeur Bain/D. Free-Standing

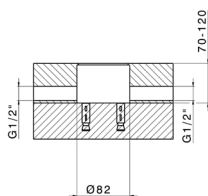
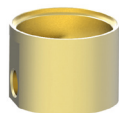

### ZB 004510

Parte Incasso Monocomando Free-Standing  
Free-Standing Mixer Concealed Part  
Partie Encastrée Mitigeur Free-Standing

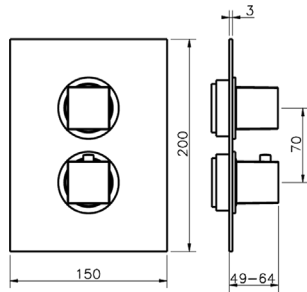

**NE 007300**

Parte Esterna Termostatico Doccia  
Thermo Shower Exposed Part  
Partie Décor Thermo Douche

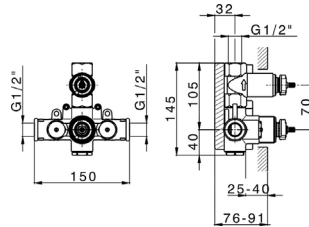

**ZB 007301**

Parte Incasso Termostatico Doccia  
Thermo Shower Concealed Part  
Partie Encastrée Thermo Douche

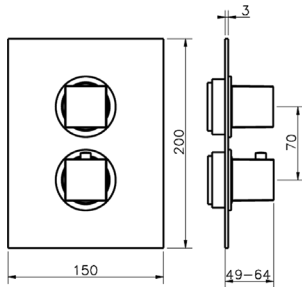

**NE 018100**

Parte Esterna Termostatico 2 Uscite  
2-Outlet Thermo Exposed Part  
Partie Décor Thermo 2 Sorties

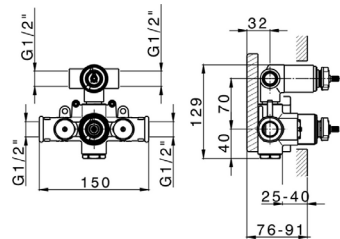
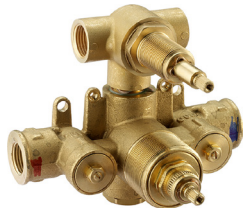

**ZB 018101**

Parte Incasso Termostatico 2 Uscite  
2-Outlet Thermo Concealed Part  
Partie Encastrée Thermo 2 Sorties

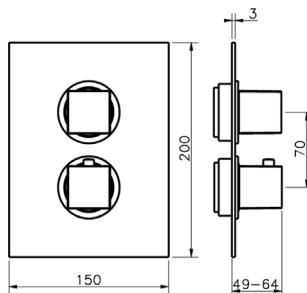

**NE 018200**

Parte Esterna Termostatico 3 Uscite  
3-Outlet Thermo Exposed Part  
Partie Décor Thermo 3 Sorties



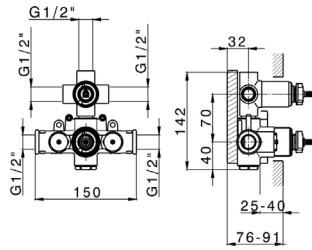

**ZB 018201**

Parte Incasso Termostatico 3 Uscite  
 3-Outlet Thermo Concealed Part  
 Partie Encastrée Thermo 3 Sorties

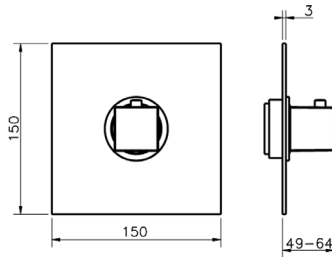

**NE 007200**

Parte Esterna Termostatico 3/4"  
 3/4" Thermo Exposed Part  
 Partie Décor Thermo 3/4"

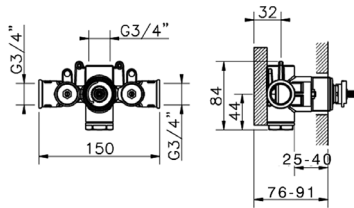
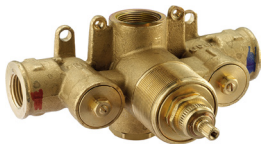

**ZB 007220**

Parte Incasso Termostatico 3/4"  
 3/4" Thermo Concealed Part  
 Partie Encastrée Thermo 3/4"

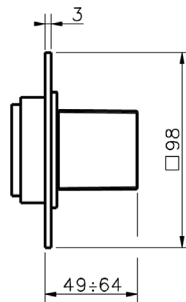

**NE 003310**

Parte Esterna Rubinetto  
 Stopvalve Exposed Part  
 Partie Décor Robinet

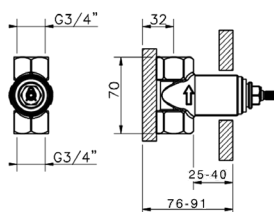

**ZB 003330**

Parte Incasso Rubinetto 3/4"  
 3/4" Stopvalve Concealed Part  
 Partie Encastrée Robinet 3/4"

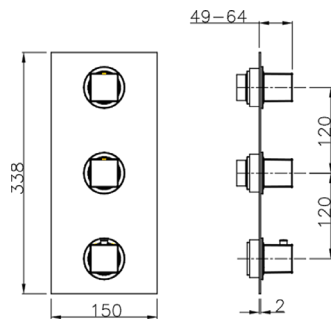

**NE 01V200**

Parte Esterna Termostatico 2 Funzioni  
 2-Function Thermo Exposed Part  
 Partie Décor Thermo 2 Fonctions

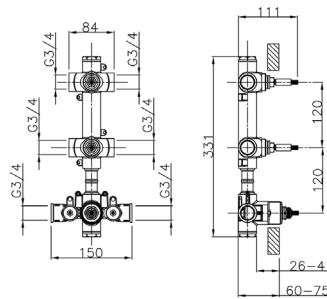

**ZB 01V200**

Parte Incasso Termostatico 2 Funzioni  
 2-Function Thermo Concealed Part  
 Partie Encastrée Thermo 2 Fonctions

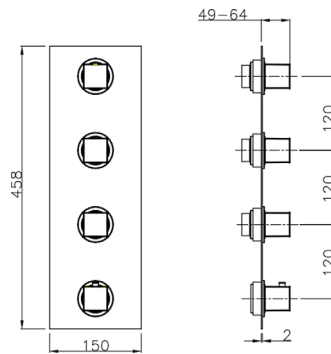
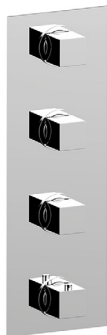

**NE 01V300**

Parte Esterna Termostatico 3 Funzioni  
 3-Function Thermo Exposed Part  
 Partie Décor Thermo 3 Fonctions

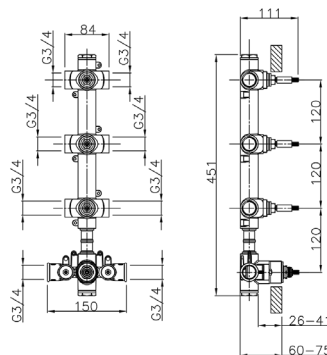

**ZB 01V300**

Parte Incasso Termostatico 3 Funzioni  
 3-Function Thermo Concealed Part  
 Partie Encastrée Thermo 3 Fonctions

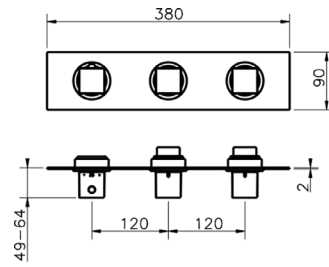

### NE 01R200

Parte Esterna Termostatico 2 Funzioni  
2-Function Thermo Exposed Part  
Partie Décor Thermo 2 Fonctions

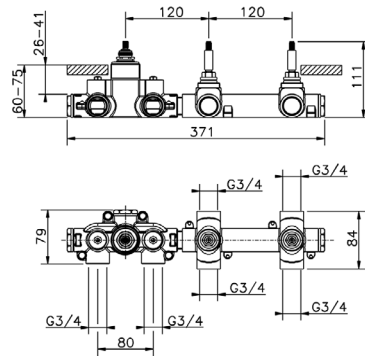

### ZB 01R200

Parte Incasso Termostatico 2 Funzioni  
2-Function Thermo Concealed Part  
Partie Encastrée Thermo 2 Fonctions

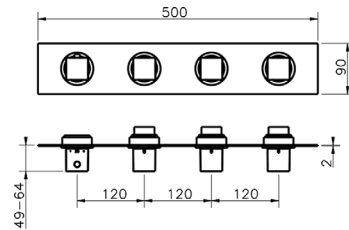

### NE 01R300

Parte Esterna Termostatico 3 Funzioni  
3-Function Thermo Exposed Part  
Partie Décor Thermo 3 Fonctions

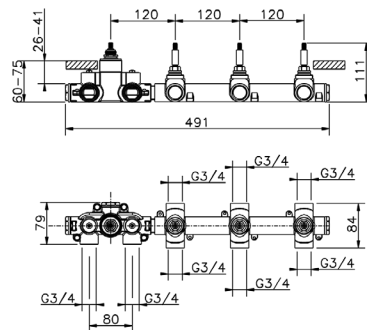

### ZB 01R300

Parte Incasso Termostatico 3 Funzioni  
3-Function Thermo Concealed Part  
Partie Encastrée Thermo 3 Fonctions

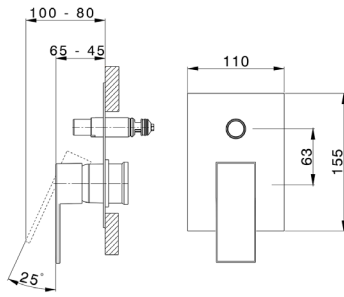

**NE 002100**

Parte Esterna Monocomando 2 Uscite  
2-Outlet Mixer Exposed Part  
Partie Décor Mitigeur 2 Sorties

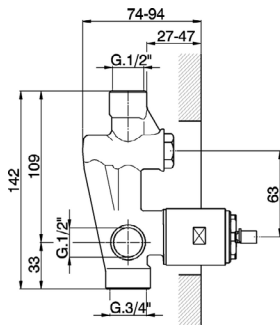

**ZB005210**

Parte Incasso Monocomando 2 Uscite  
2-Outlet Mixer Concealed Part  
Partie Encastrée Mitigeur 2 Sorties

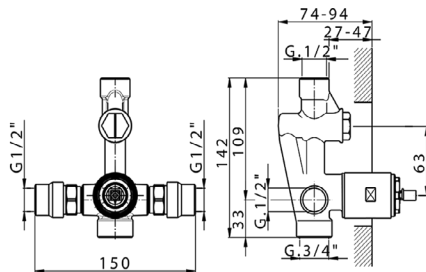

**ZB 005211**

Parte Incasso Monocomando 2 Uscite con Silenziatori  
2-Outlet Mixer Concealed Part with Noise Reducers  
Partie Encastrée Mitigeur 2 Sorties avec Silencieux

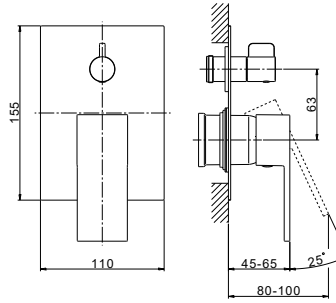

### NE 002300

Parte Esterna Monocomando 2 Uscite  
2-Outlet Mixer Exposed Part  
Partie Décor Mitigeur 2 Sorties

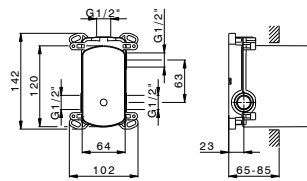

### ZB 000230

Parte Incasso Monocomando 2 Uscite  
2-Outlet Mixer Concealed Part  
Partie Encastrée Mitigeur 2 Sorties

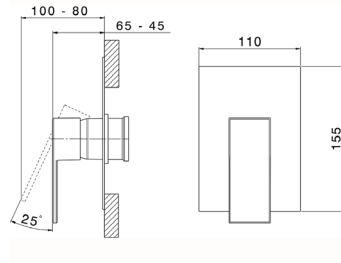

**NE 003000**

Parte Esterna Monocomando Doccia  
Shower Mixer Exposed Part  
Partie Décor Mitigeur Douche

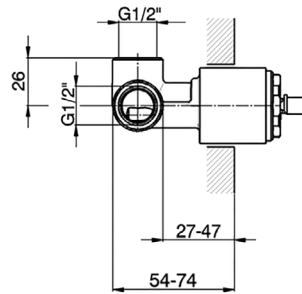

**ZB 005300**

Parte Incasso Monocomando Doccia  
Shower Mixer Concealed Part  
Partie Encastrée Mitigeur Douche

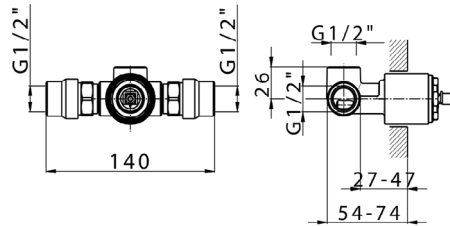

**ZB 005301**

Parte Incasso Monocomando Doccia con Silenziatori  
Shower Mixer Concealed Part with Noise Reducers  
Partie Encastrée Mitigeur Douche avec Silencieux

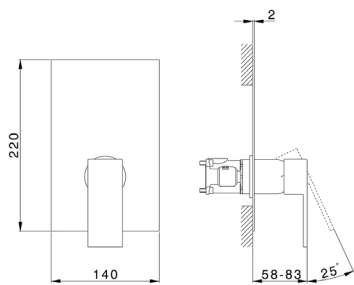

### NE OBM010

Parte Esterna Monocomando 1 Uscita  
1-Outlet Mixer Exposed Part  
Partie Décor Mitigeur 1 Sortie

Vedi/See/Voir **ONE Box**

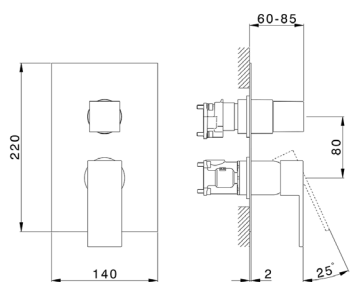
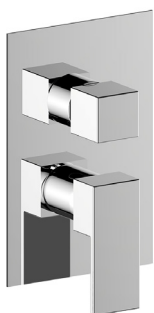

### NE OBM030

Parte Esterna Monocomando 2/3 Uscite  
2/3 Outlet Mixer Exposed Part  
Partie Décor Mitigeur 2/3 Sorties

Vedi/See/Voir **ONE Box**

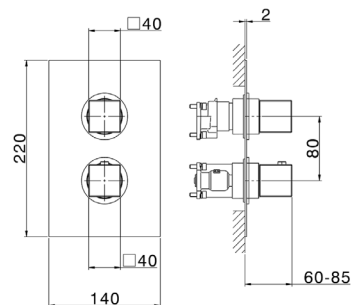
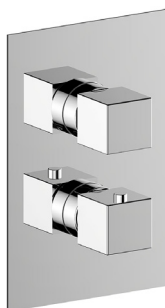

### NE OBT030

Parte Esterna Termostatico 1/2/3 Uscite  
1/2/3 Outlet Thermo Exposed Part  
Partie Décor Thermo 1/2/3 Sorties

Vedi/See/Voir **ONE Box**

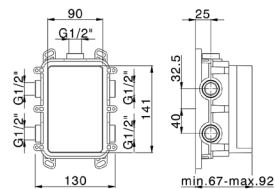

### ZB 00B030

Parte Incasso ONE Box  
ONE Box Concealed Part  
Partie Encastrée ONE Box

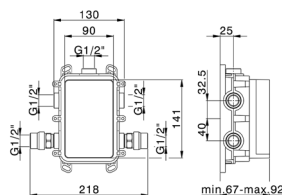

### ZB 00B031

Parte Incasso ONE Box con Silenziatori  
ONE Box Concealed Part with Noise Reducers  
Partie Encastrée ONE Box avec Silencieux

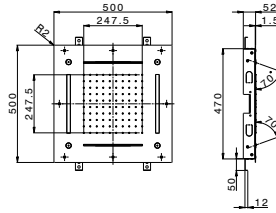
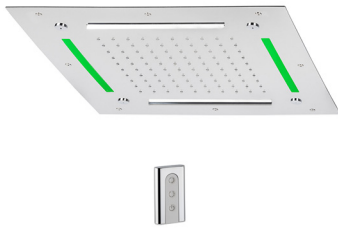

### ZS 1C0090

Soffione a Soffitto con Cromoterapia  
Funzioni Pioggia, Nebulizzazione, 2 Cascate  
Radiocomando

Chromotherapy Ceiling Shower Head  
Rain, Spaying Functions, 2 Waterfalls  
Remote Control

Pomme de Douche Plafond avec Chromothérapie  
Fonctions Pluie, Nébuliseur, 2 Cascades  
Télécommande

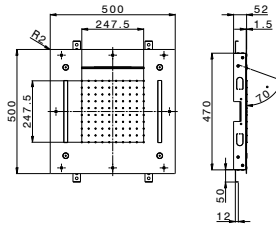
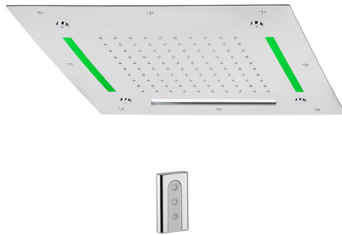

### ZS 1C0080

Soffione a Soffitto con Cromoterapia  
Funzioni Pioggia, Nebulizzazione, Cascata  
Radiocomando

Chromotherapy Ceiling Shower Head  
Rain, Spaying Functions, Waterfall  
Remote Control

Pomme de Douche Plafond avec Chromothérapie  
Fonctions Pluie, Nébuliseur, Cascade  
Télécommande

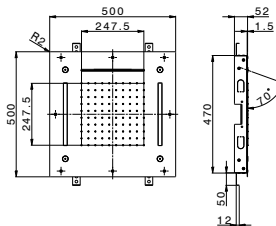

### ZS 1C0085

Soffione a Soffitto con Cromoterapia  
Funzioni Pioggia, Nebulizzazione, Cascata  
Comando a Incasso

Chromotherapy Ceiling Shower Head  
Rain, Spaying Functions, Waterfall  
Built-in Control

Pomme de Douche Plafond avec Chromothérapie  
Fonctions Pluie, Nébuliseur, Cascade  
Commande Intégrée

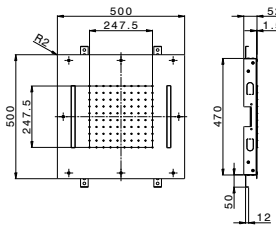
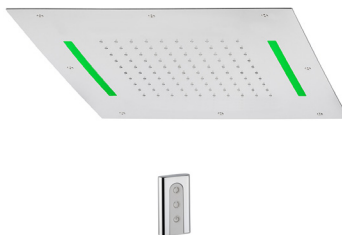

### ZS 1C0070

Soffione a Soffitto con Cromoterapia  
Funzione Pioggia - Radiocomando  
Chromotherapy Ceiling Shower Head  
Rain Function - Remote Control

Pomme de Douche Plafond avec Chromothérapie  
Fonctions Pluie - Télécommande

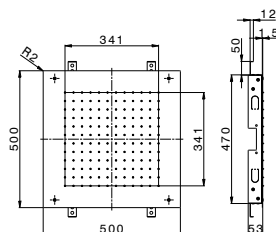

### ZS 1S0130

Soffione a Soffitto  
Funzione Pioggia  
Ceiling Shower Head  
Rain Function

Pomme de Douche Plafond  
Fonctions Pluie



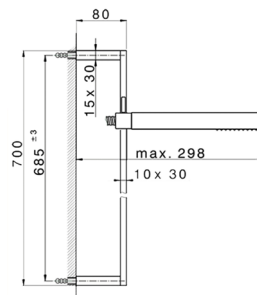

**SS 010860**  
Completo Doccia Saliscendi  
Slide Rail Shower Set  
Ensemble Barre de Douche

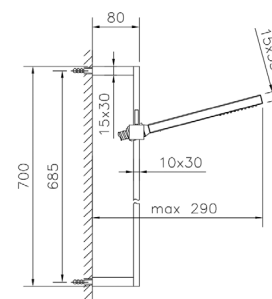

**SS 010770**  
Completo Doccia Saliscendi  
Slide Rail Shower Set  
Ensemble Barre de Douche

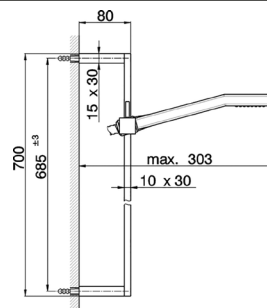

**SS 010040**  
Completo Doccia Saliscendi  
Slide Rail Shower Set  
Ensemble Barre de Douche

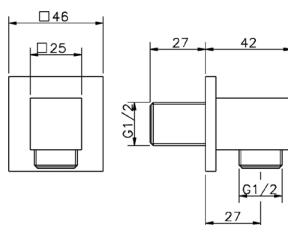

**SS 017340**  
Presa d'Acqua  
Wall Elbow  
Coude Mural

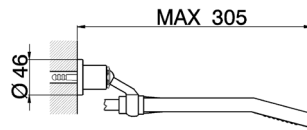

**SS 018080**  
Completo Doccia  
Shower Set  
Ensemble de Douche

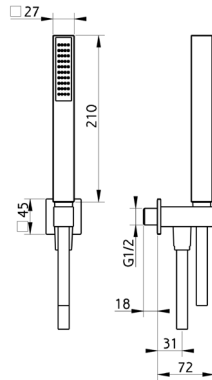

**SS 018970**  
Completo Doccia con Presa d'Acqua  
Shower Set on Wall Elbow  
Ensemble de Douche sur Coude Mural

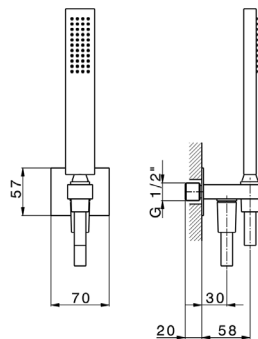

**SS 018860**  
Completo Doccia con Presa d'Acqua  
Shower Set on Wall Elbow  
Ensemble de Douche sur Coude Mural

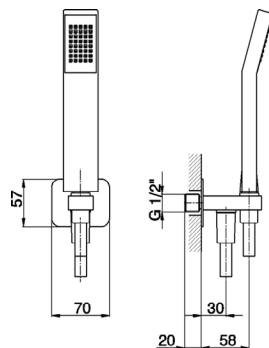

**SS 018800**  
Completo Doccia con Presa d'Acqua  
Shower Set on Wall Elbow  
Ensemble de Douche sur Coude Mural

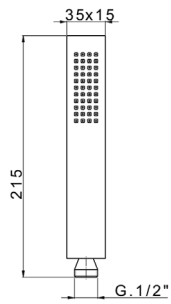

**SS 014450**  
Doccetta  
Hand Shower  
Douchette à Main

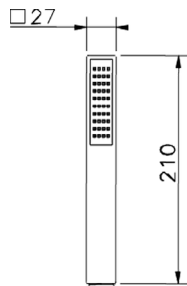

**SS 014400**  
Doccetta  
Hand Shower  
Douchette à Main

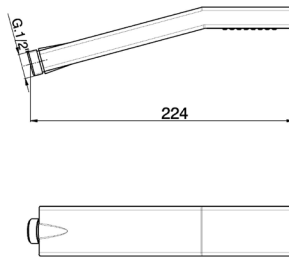

**SS 014180**  
Doccetta  
Hand Shower  
Douchette à Main

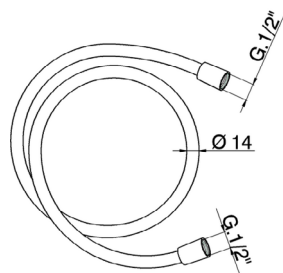

**ZB 009040**  
Flessibile Doccia SUPREME  
SUPREME Shower Hose  
Flexible de Douche SUPREME

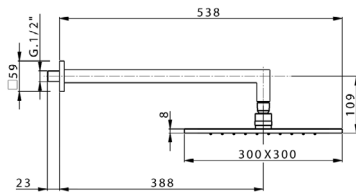

**SS 013720**

Braccio e Soffione Doccia  
Shower Arm & Head  
Bras et Tête de Douche

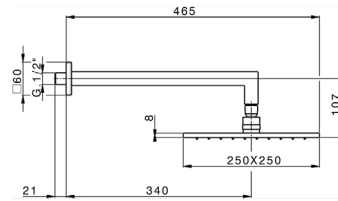

**SS 013660**

Braccio e Soffione Doccia  
Shower Arm & Head  
Bras et Tête de Douche

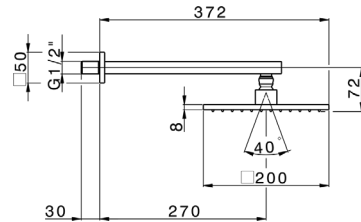
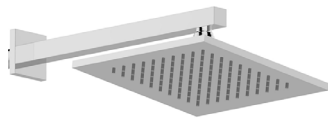

**SS 013650**

Braccio e Soffione Doccia  
Shower Arm & Head  
Bras et Tête de Douche

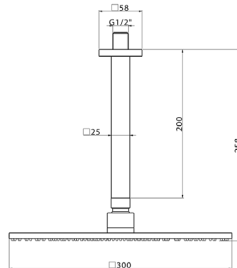

**SS 013660**

Braccio e Soffione Doccia  
Shower Arm & Head  
Bras et Tête de Douche

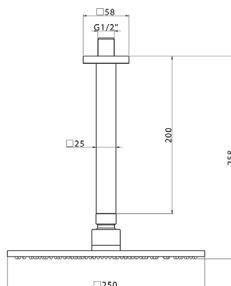

**SS 013650**

Braccio e Soffione Doccia  
Shower Arm & Head  
Bras et Tête de Douche

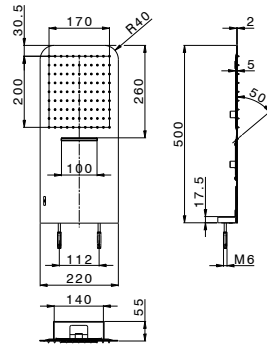

### ZS 122110

Soffione Doccia 2 Funzioni: Poggia/Cascata  
2-Function Shower Head: Rain/Waterfall  
Douche de Tête 2 Fonctions: Pluie/Cascade

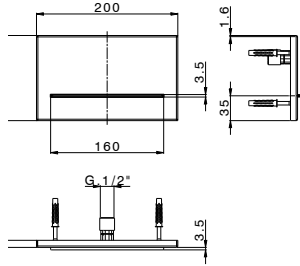

### ZS 129120

Cascata a Parete  
Wall-Mounted Waterfall Spout  
Cascade murale

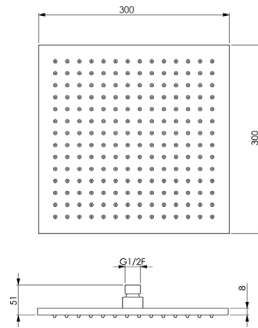

### SS 016340

Soffione Doccia  
Shower Head  
Douche de Tête

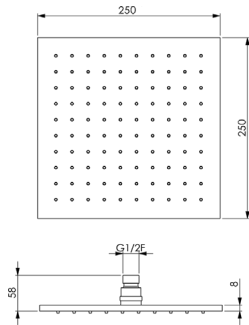

### SS 016360

Soffione Doccia  
Shower Head  
Douche de Tête

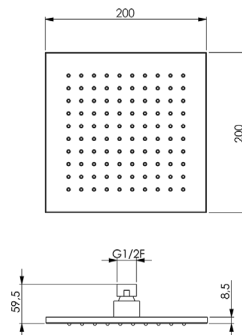

### SS 016320

Soffione Doccia  
Shower Head  
Douche de Tête

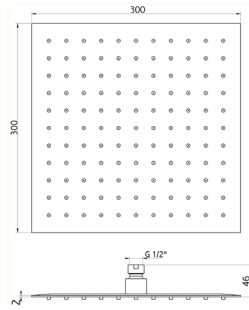
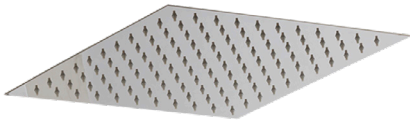

**SS 016670**  
Soffione Doccia  
Shower Head  
Douche de Tête

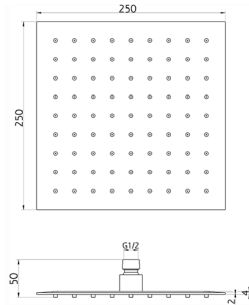
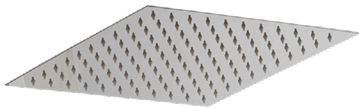

**SS 016760**  
Soffione Doccia  
Shower Head  
Douche de Tête

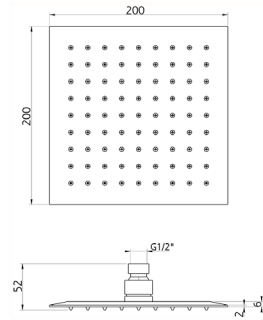
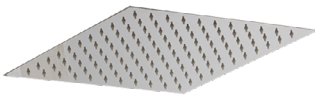

**SS 016620**  
Soffione Doccia  
Shower Head  
Douche de Tête

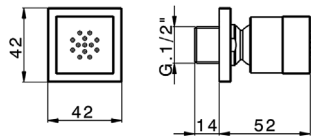

**SS 015080**  
Soffione Laterale  
Body Jet  
Buse Murale

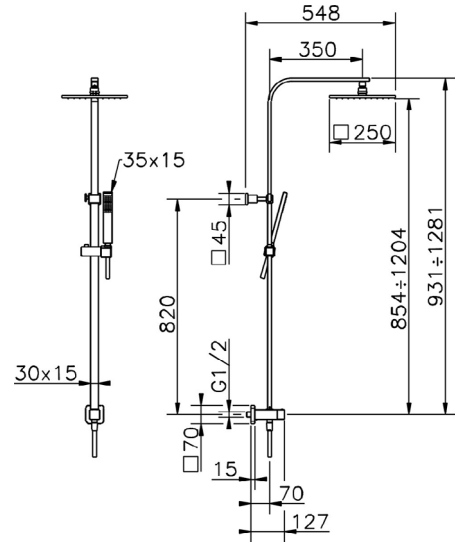

### SS V86020

Completo Doccia con Presa d'Acqua  
Shower Set on Wall Elbow  
Ensemble de Douche sur Coude Mural

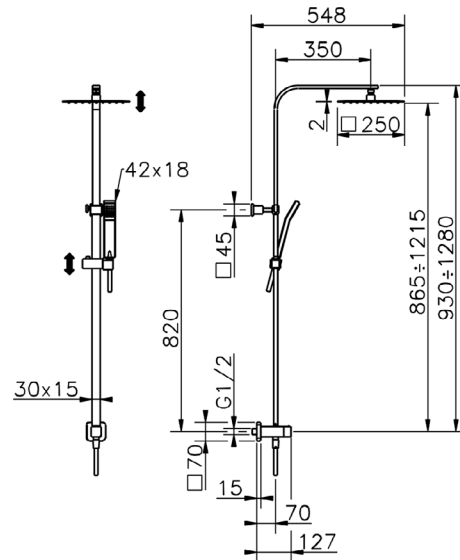

### SS V86030

Completo Doccia con Presa d'Acqua  
Shower Set on Wall Elbow  
Ensemble de Douche sur Coude Mural



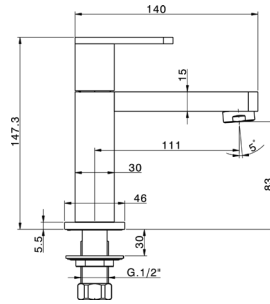

**DD 000900**  
 Rubinetto Lavamani  
 Pillar Tap  
 Robinet Lave Mains

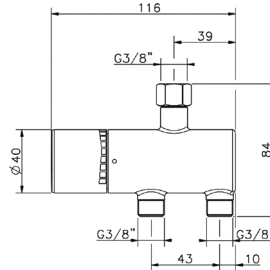

**TY T83010**  
 Termostatico Sottolavabo  
 Underbasin Thermo  
 Thermo Sous Lavabo

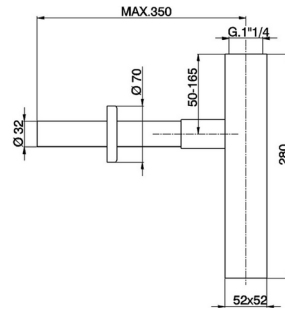

**ZB 004080**  
 Sifone  
 Siphon  
 Siphon

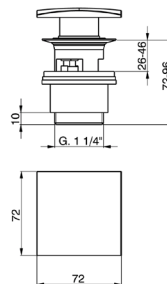

**ZB 001622**  
 Scarico Click-Clack  
 Click-Clack Waste  
 Vidage Click-Clack

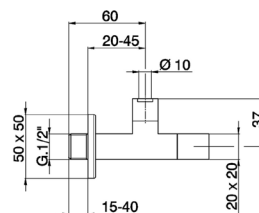

**ZB 002910**  
 Rubinetto Filtro di Alimentazione  
 Angle Valve  
 Robinet à equerre



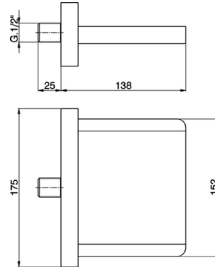
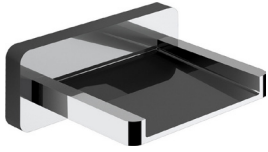

**ZB 002190**  
Bocca a Cascata  
Waterfall Spout  
Bec Cascade

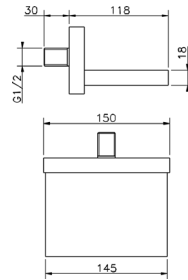
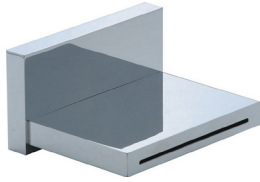

**ZB 002200**  
Bocca a Cascata  
Waterfall Spout  
Bec Cascade

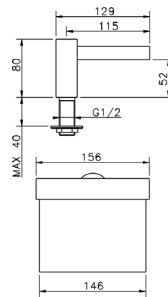

**ZB 002620**  
Bocca Vasca a Cascata  
Waterfall Bath Spout  
Bec Bain Cascade

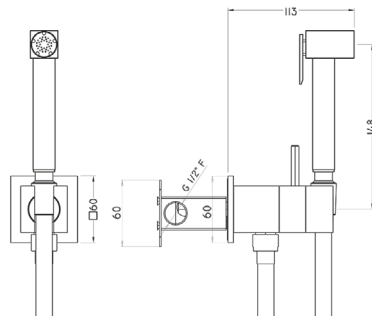
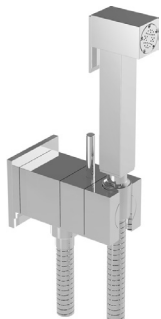

**EG 007945**  
Set Miscelatore Doccetta Igienica  
Bidet Hand Shower Mixer Set  
Kit Mitigeur Douche d'Hygiène

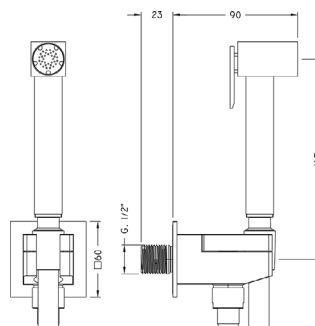
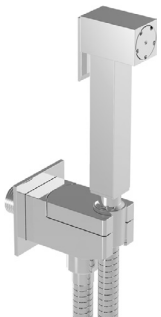

**EG 007930**  
Set Miscelatore Doccetta Igienica  
Bidet Hand Shower Mixer Set  
Kit Mitigeur Douche d'Hygiène



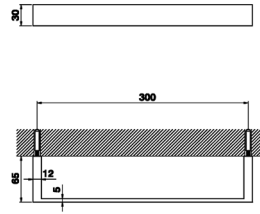

**SQ 090104**  
Porta Salviette  
Towel Rail  
Porte-Serviette

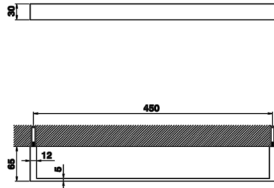

**SQ 090105**  
Porta Salviette  
Towel Rail  
Porte-Serviette

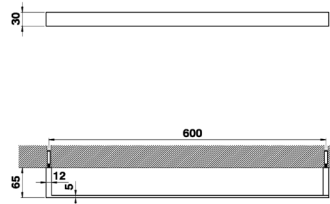
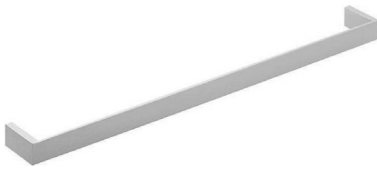

**SQ 090106**  
Porta Salviette  
Towel Rail  
Porte-Serviette

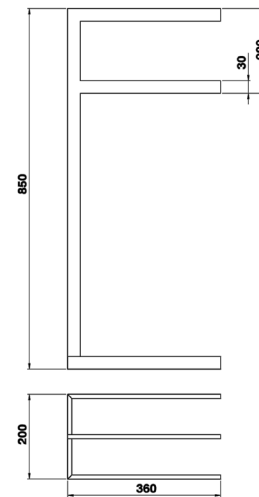

**SQ 090910**  
Porta Salviette  
Free-Standing Towel Rail  
Porte-Serviette

# NUOVA EGO

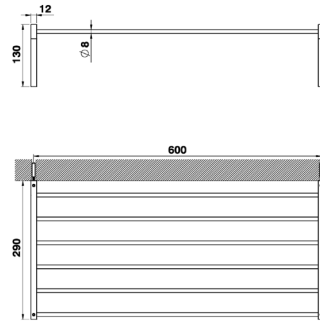

**SQ 090300**  
Porta Salviette  
Towel Rail  
Porte-Serviette

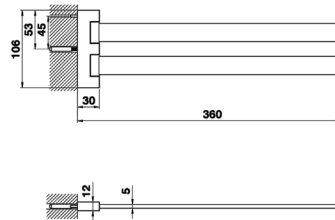
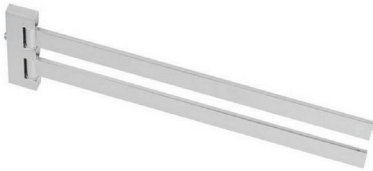

**SQ 090210**  
Porta Salviette  
Towel Rail  
Porte-Serviette

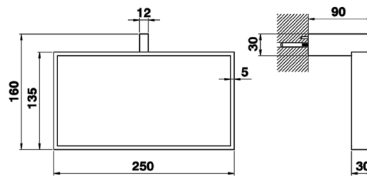
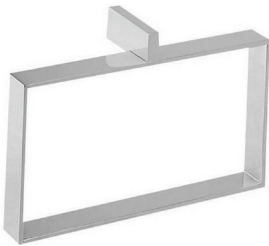

**SQ 090220**  
Porta Salviette  
Towel Rail  
Porte-Serviette

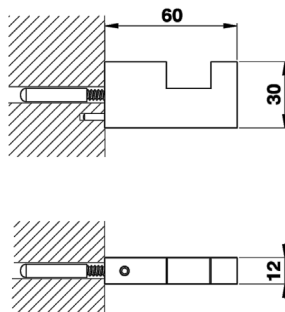
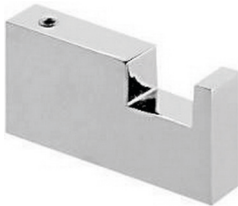

**SQ 090710**  
Appendino  
Robe Hook  
Porte-Peignoir

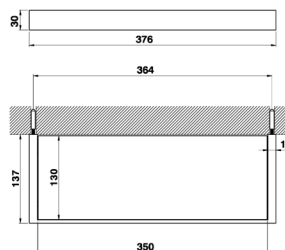

**SQ 090441**  
Mensola  
Shelf  
Console

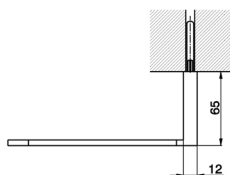
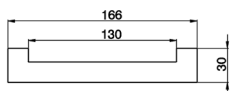
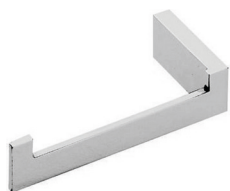

**SQ 090402**

Porta Rotolo  
Roll Holder  
Porte-Papier

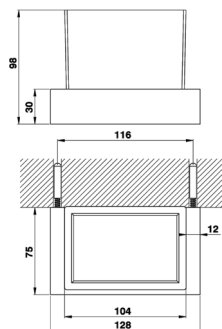
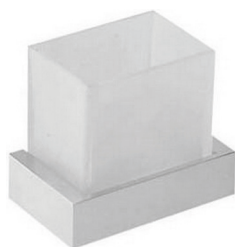

**SQ 090501**

Porta Bicchieri  
Toothbrush Holder  
Porte-Verre

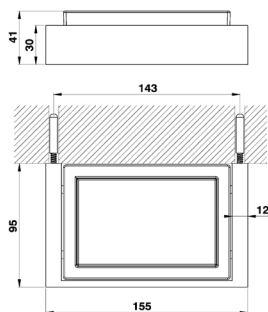

**SQ 090601**

Porta Sapone  
Soap Holder  
Porte-Savon

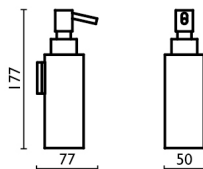

**SQ 090622**

Dispenser Sapone  
Soap Dispenser  
Diffuseur de Savon

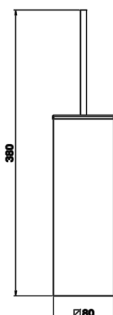

**SQ 090650**

Porta Scopino  
Brush Holder  
Porte-Brosse

# NUOVA EGO

*Finishes Programme.*

Programma Finiture.

## *Classic Metals | Metalli Classici*



Chrome  
21



Brushed Nickel  
2F

## *Special Metals | Metalli Speciali*



Black Titanium  
2Q

## *Colours | Colori*



Night Black  
40



Snow White  
4Q



# *Credits.* Crediti.

*Text and Editing*

**HuberLab**

*Graphic Design and Layout*

**HuberLab**

*Photography*

**Dario De Sirianna**

**Marco Siracusano**

**Giuseppe Godi**

*Printing*

**Tipolitografia Testori**

Printed in Italy



Via Brughiere 50 - 28017 San Maurizio d'Opaglio - Italia

+39 0322 967783

huber@huberitalia.com

huberitalia.com

