

Parte externa termostático ducha empotrada CROISSETTE_CS007200



MODELO **CS007200**

Parte externa termostático ducha empotrada, sin llave de paso, sin parte empotrada, para art. ZB007201-ZB007221

ACABADOS DISPONIBLES

-  **21** 21 Cromo
-  **27** 27 Bronce Viejo
-  **2G** 2G Oro Viejo
-  **2W** 2W Oro Cepillado

CARACTERÍSTICAS

Instalación	Empotrado
Empotrado 2	ZB007221
	ZB007201

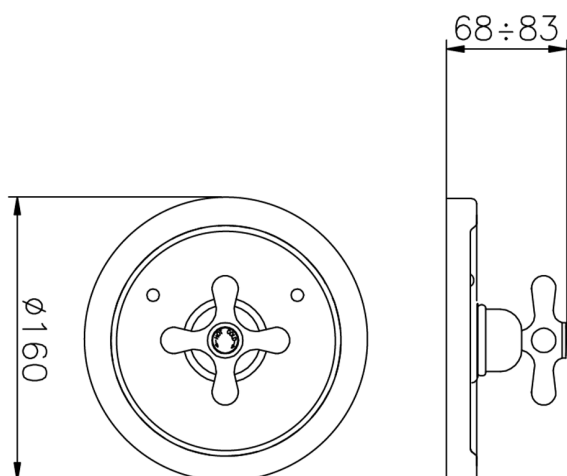

Termostático

El Termostático Huber es tu gestor personal del agua, ayudándote a manejar, controlar y ahorrar agua y energía.



Parte empotrada termostático ducha 3/4" EMPOTRADO_ZB007221

MODELO **ZB007221**

Parte empotrada termostático 3/4", sin llave de paso, sin parte externa

ACABADOS DISPONIBLES

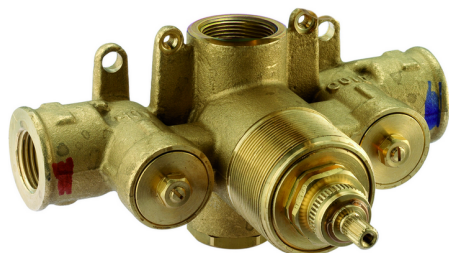
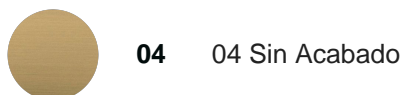

CARACTERÍSTICAS

Instalación **Empotrado**

Recambio Cartucho **23.51A.HF**

Cartucho Termostático HF

Empotrado **1**

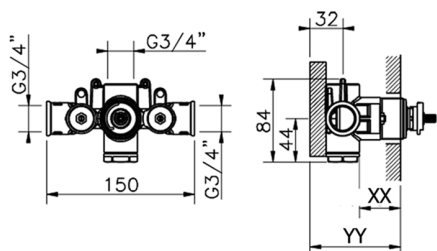

Piastra/Plate/Plaque/Platte/Placa
 2-3mm: XX 25-40 YY 76-91
 10mm: XX 16-31 YY 65-80



Termostático

El Termostático Huber es tu gestor personal del agua, ayudándote a manejar, controlar y ahorrar agua y energía.



Parte empotrada termostático ducha 1/2" EMPOTRADO_ZB007201

MODELO **ZB007201**

Parte empotrada termostático ducha 1/2", sin llave de paso, sin parte externa

ACABADOS DISPONIBLES

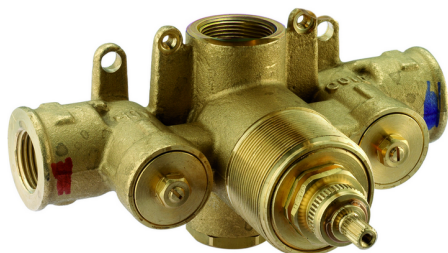

CARACTERÍSTICAS

Instalación	Empotrado
Recambio Cartucho	24.04A.PP
	Cartucho Termostático Plus P 8X20
Empotrado	1

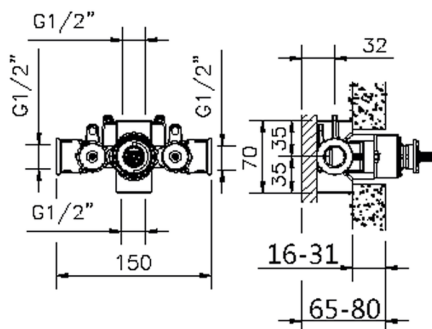

Termostático

El Termostático Huber es tu gestor personal del agua, ayudándote a manejar, controlar y ahorrar agua y energía.



2024-11-23