

Parte externa termostático ducha emp. 2 salidas CHRONOS_CR019100



MODELO **CR019100**

Parte externa termostático ducha emp.2 salidas,con deviasstop 2 salidas,sin parte empotrada,para art.ZB019100

ACABADOS DISPONIBLES

-  **21** 21 Cromo
-  **2F** 2F Níquel Cepillado
-  **2Q** 2Q Black Titanium

CARACTERÍSTICAS

Instalación **Empotrado**
Empotrado 1 **ZB019100**

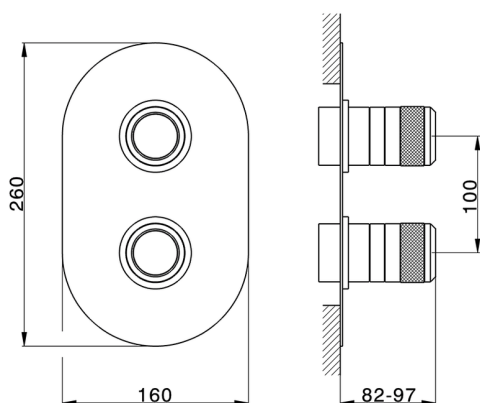

Termostático

El Termostático Huber es tu gestor personal del agua, ayudándote a manejar, controlar y ahorrar agua y energía.



Parte empotrada termostático ducha 2 salidas EMPOTRADO_ZB019100

MODELO **ZB019100**

Parte empotrada termostático ducha 2 salidas, con deviasión 2 salidas 1/2", sin parte externa

ACABADOS DISPONIBLES



04 04 Sin Acabado



CARACTERÍSTICAS

Instalación	Empotrado
Recambio Cartucho	24.04A.PP
	Cartucho Termostático Plus P 8X20
Empotrado	1

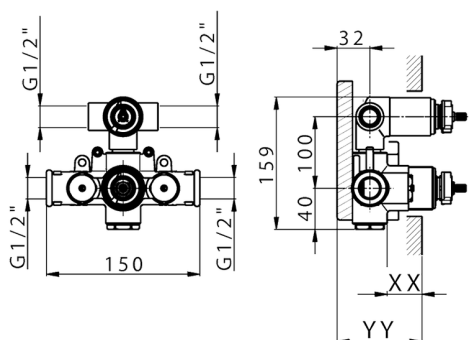

Piastra/Plate/Plaque/Platte/Placa
 2-3mm: XX 25-40 YY 76-91
 10mm: XX 21-34 YY 70-83



Termostático

El Termostático Huber es tu gestor personal del agua, ayudándote a manejar, controlar y ahorrar agua y energía.



2025-01-31