

Ducha termostática con barra-corrediza VICTORIAN_VTS01010



MODELO **VTS01010**

Ducha termostática con barra-corrediza, barra corrediza con soporte deslizante 56 cm, duchita una función clásica de latón, Ø 78 mm, flexible de Latón 150 cm

ACABADOS DISPONIBLES

-  **21** 21 Cromo
-  **27** 27 Bronce Viejo
-  **2A** 2A Niquel Satinado Cepillado
-  **2G** 2G Oro Viejo

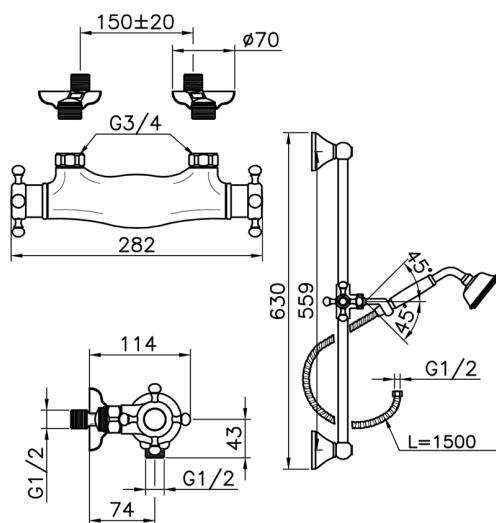

CARACTERÍSTICAS

Recambio Cartucho **24.04A.PP**

Cartucho Termostático Plus P 8X20



Termostático

El Termostático Huber es tu gestor personal del agua, ayudándote a manejar, controlar y ahorrar agua y energía.



2024-11-21