

## Parte externa monomando lavabo de pared H3\_AH005511

MODELO **AH005511**

Parte externa monomando lavabo de pared, sin parte empotrada, caño L.200 mm, para art. Easy-Box ZB002450 y art. ZB025510



### ACABADOS DISPONIBLES

-  **21** 21 Cromo
-  **2F** 2F Níquel Cepillado
-  **40** 40 Negro Mate

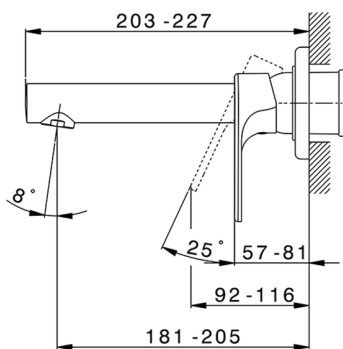
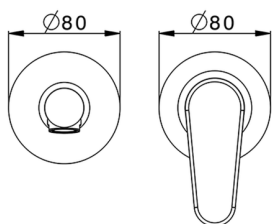

### CARACTERÍSTICAS

|             |                  |
|-------------|------------------|
| Instalación | <b>Empotrado</b> |
| Empotrado 1 | <b>ZB002450</b>  |



## Parte externa monomando lavabo de pared H3\_AH005511

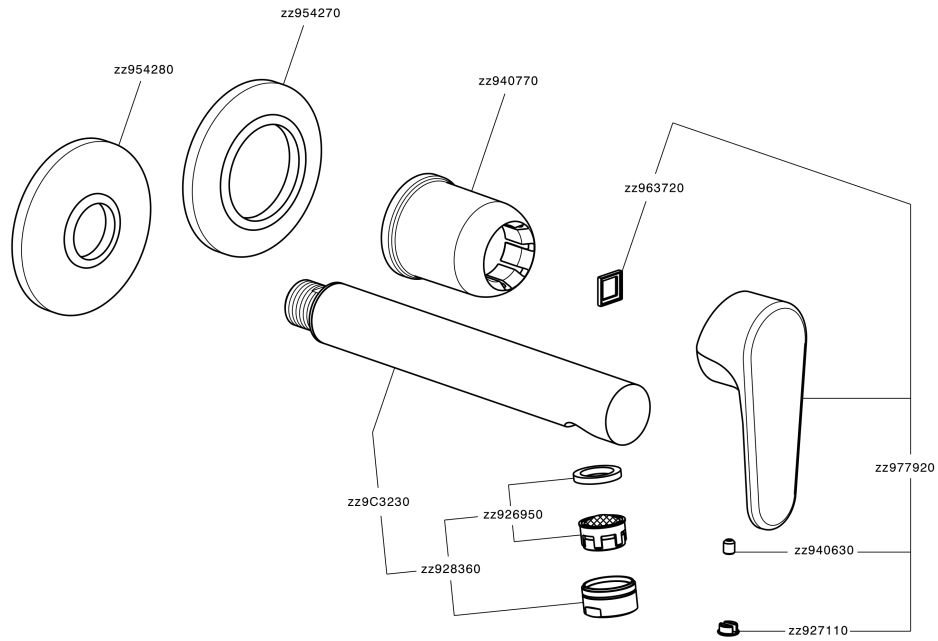

AH005511

<https://es.huberitalia.com/parte-externa-monomando-lavabo-de-pared-h3-ah005511>

## Parte empotrada monomando lavabo de pared Easy-Box EMPOTRADO\_ZB002450

MODELO **ZB002450**

Parte empotrada monomando lavabo de pared Easy-Box, con caja de protección, sin parte externa

ACABADOS DISPONIBLES



CARACTERÍSTICAS

|                                 |                   |
|---------------------------------|-------------------|
| Instalación                     | <b>Empotrado</b>  |
| Recambio Cartucho               | <b>ZZ95409000</b> |
| <b>Cartucho Monomando 35 mm</b> |                   |
| Empotrado                       | <b>1</b>          |



Piastra/Plate/Plaque/Platte/Placa

2-3mm: XX 56-76

10mm: XX 48-68



### DeviaStop

La tecnología Huber DeviaStop le permite ajustar el caudal de agua y dirigirla hacia la salida elegida (rociador superior, ducha de mano, etc.).



2026-05-20