

Ducha monomando

MODELO **ZR000444**

Ducha monomando, sin conjunto ducha, conexión para flexible 1/2" M

ACABADOS DISPONIBLES



21 21 Cromo

CARACTERÍSTICAS

Recambio Cartucho **ZZ94035000**

Cartucho Monomando 35 mm

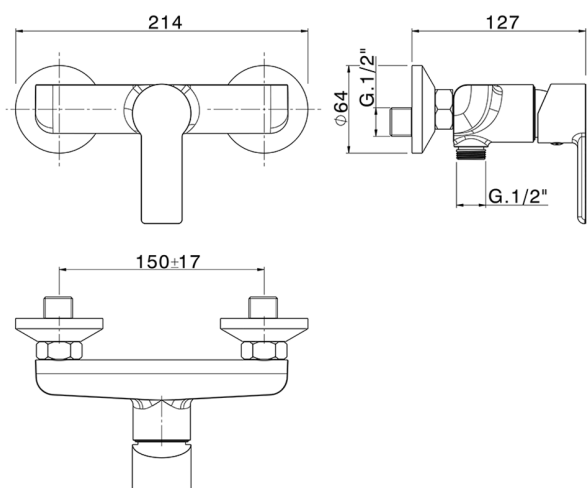

2026-06-10