

## Bañera monomando NORMA\_NM000130

MODELO **NM000130**

Bañera monomando, sin conjunto ducha, conexión para flexible 1/2" M



ACABADOS DISPONIBLES



CARACTERÍSTICAS

Recambio Cartucho **ZZ94034000**

**Cartucho Monomando 35 mm**

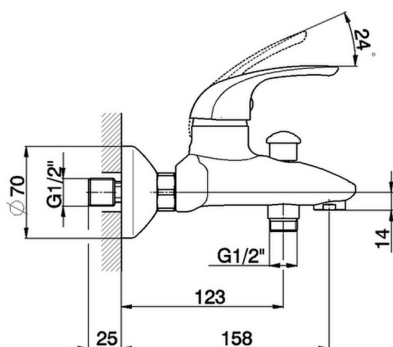

## Bañera monomando NORMA\_NM000130

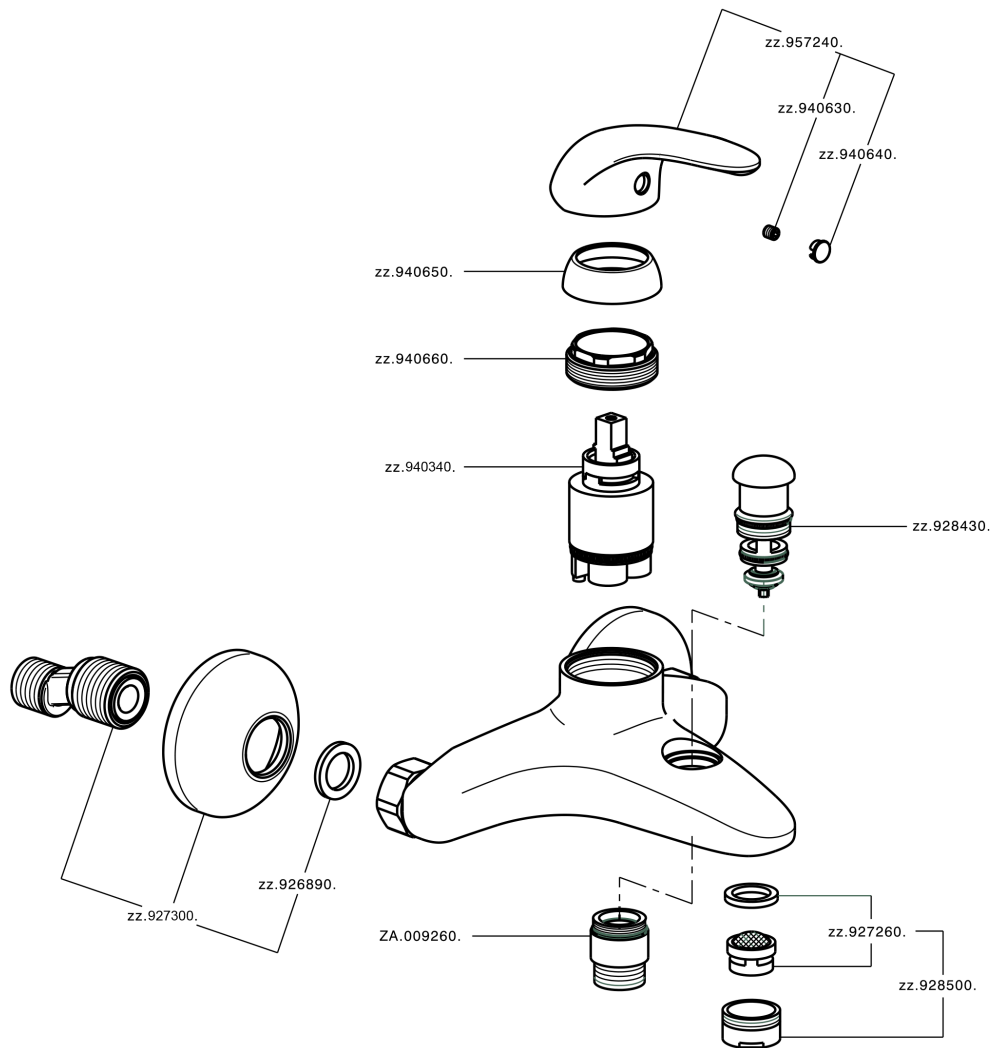

NM000130

<https://es.huberitalia.com/banera-monomando-norma-nm000130>

2026-05-20