

Parte externa termostático ducha emp. 2 salidas HARLOCK_HC018100

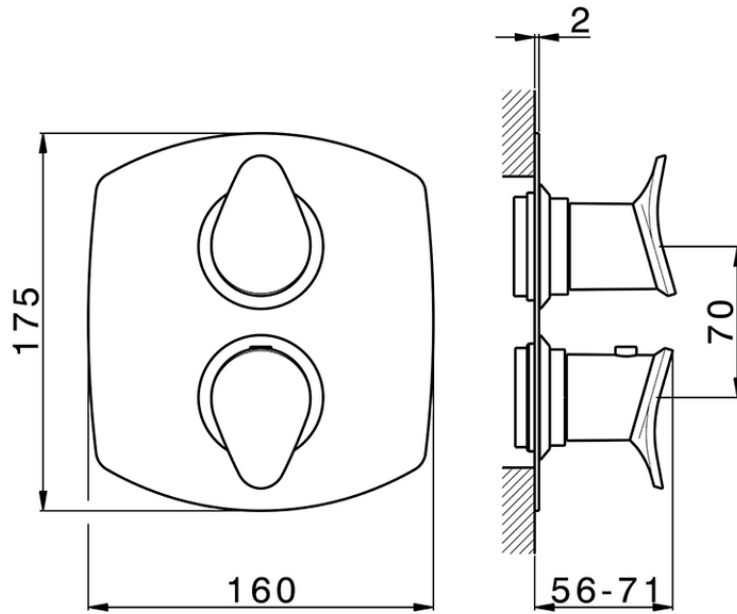

HC018100

<https://es.huberitalia.com/parte-externa-termostatico-ducha-emp-2-salidas-harlock-hc018100>



Piastra/Plate/Plaque/Platte/Placa

2-3mm: XX 25-40 YY 76-91

10 mm: XX 16-31 YY 65-80

ZB018100

<https://es.huberitalia.com/parte-empotrada-termostatico-ducha-2-salidas-empotrado-zb018100>

2025-02-22