





Parte externa monomando empotrado 2 salidas LEVITY_LY002300

MODELO **LY002300**

Parte externa monomando empotrado 2 salidas, Desviador giratorio 2 salidas, sin parte empotrada, para art. Easy-Box ZB000230

ACABADOS DISPONIBLES

-  **21** 21 Cromo
-  **2B** 2B Níquel Brillo
-  **2F** 2F Níquel Cepillado
-  **40** 40 Negro Mate
-  **4Q** 4Q Blanco Mate

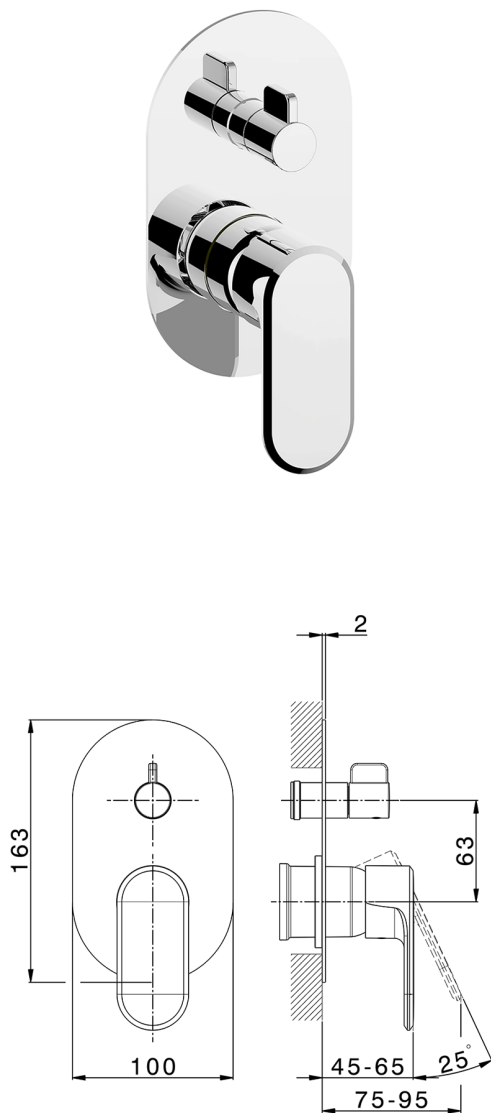

CARACTERÍSTICAS

Instalación **Empotrado**
 Empotrado 1 **ZB000230**



Parte externa monomando empotrado 2 salidas LEVITY_LY002300

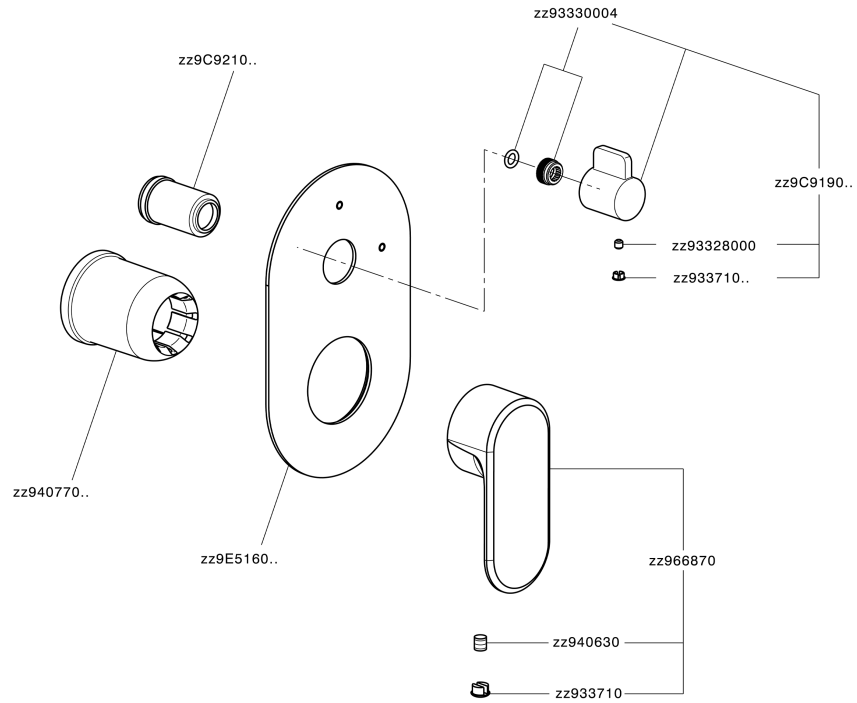

LY002300

<https://es.huberitalia.com/parte-externa-monomando-empotrado-2-salidas-levity-ly002300>

Parte empotrada monomando baño/ducha Easy-Box EMPOTRADO_ZB000230

MODELO **ZB000230**

Parte empotrada monomando baño/ducha Easy-Box, Desviador giratorio 2 salidas, sin parte externa, con caja de protección

ACABADOS DISPONIBLES



04 04 Sin Acabado

CARACTERÍSTICAS

Instalación	Empotrado
Recambio Cartucho	ZZ92909000
Cartucho Monomando 35 mm	
Empotrado	1

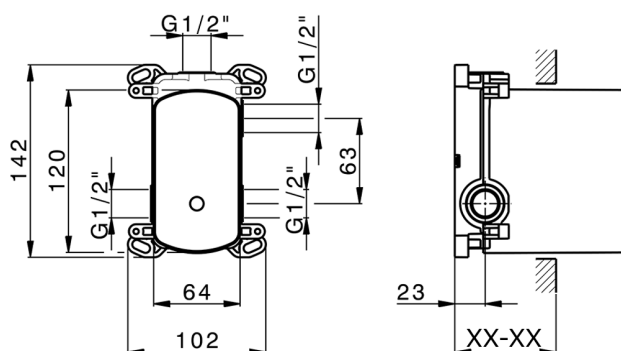

Piastra/Plate/Plaque/Platte/Placa

2-3mm: XX 65-85

10mm: XX 60-80



2026-04-30