

Parte externa monomando empotrado 2 salidas NUOVA KIRUNA_K2002300

MODELO **K2002300**

Parte externa monomando empotrado 2 salidas, Desviador giratorio 2 salidas, sin parte empotrada, para art. Easy-Box ZB000230

ACABADOS DISPONIBLES

-  **21** 21 Cromo
-  **26** 26 Cobre Viejo
-  **2F** 2F Níquel Cepillado
-  **2W** 2W Oro Cepillado
-  **40** 40 Negro Mate
-  **4Q** 4Q Blanco Mate

CARACTERÍSTICAS

Instalación **Empotrado**
 Empotrado 1 **ZB000230**

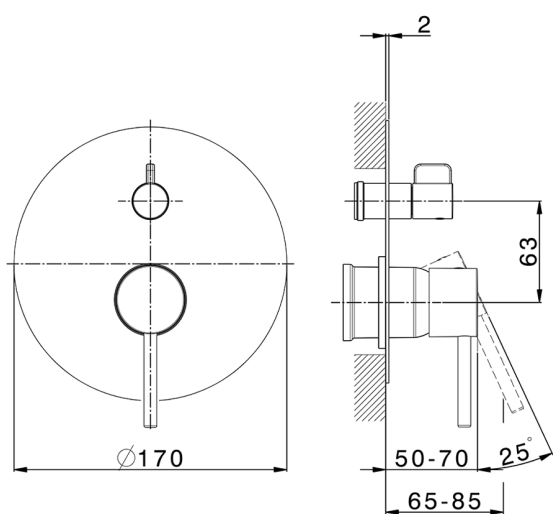

Parte externa monomando empotrado 2 salidas NUOVA KIRUNA_K2002300

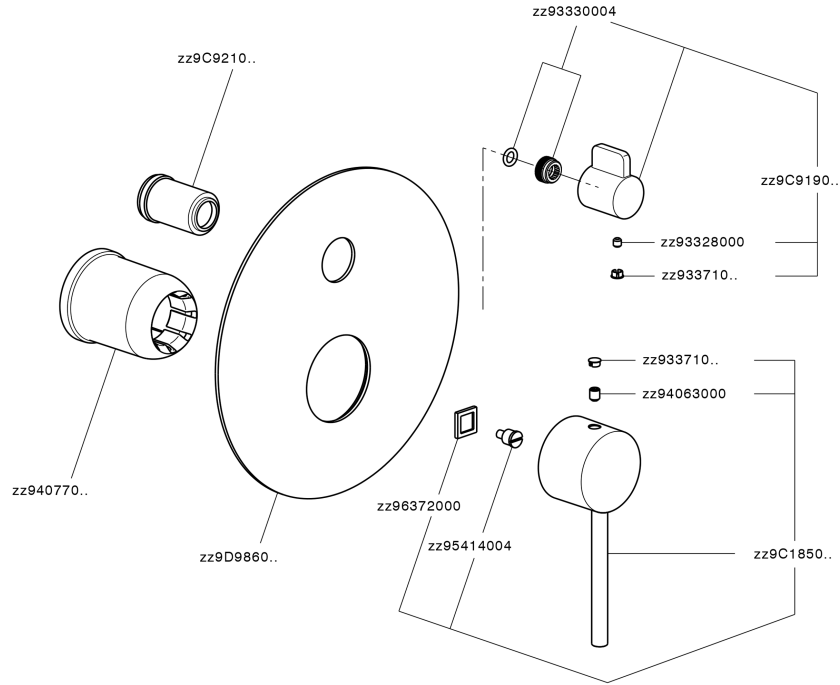

K2002300

<https://es.huberitalia.com/parte-externa-monomando-empotrado-2-salidas-nuova-kiruna-k2002300>

Parte empotrada monomando baño/ducha Easy-Box EMPOTRADO_ZB000230

MODELO **ZB000230**

Parte empotrada monomando baño/ducha Easy-Box, Desviador giratorio 2 salidas, sin parte externa, con caja de protección

ACABADOS DISPONIBLES



04 04 Sin Acabado

CARACTERÍSTICAS

Instalación	Empotrado
Recambio Cartucho	ZZ92909000
Cartucho Monomando 35 mm	
Empotrado	1

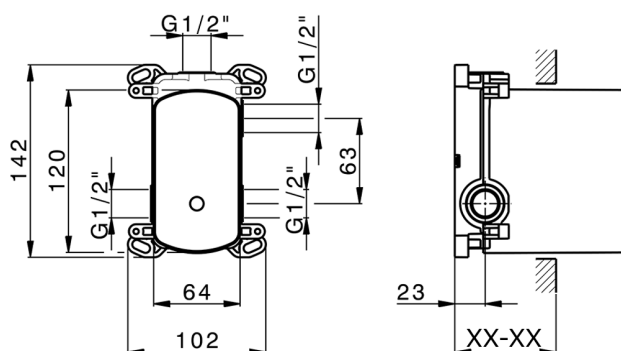

Piastra/Plate/Plaque/Platte/Placa

2-3mm: XX 65-85

10mm: XX 60-80



2026-04-30