

## Toma de agua SHOWER\_67.01H.

MODELO **67.01H.**

Toma de agua

ACABADOS DISPONIBLES



CARACTERÍSTICAS

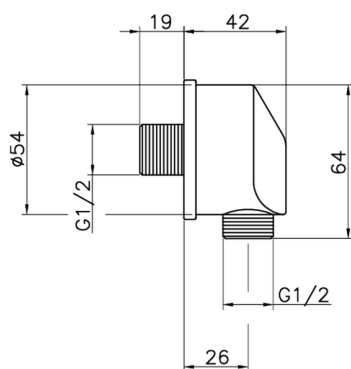

2026-04-17