

## Parte externa termostático empotrado 3 salidas M32\_MT018200

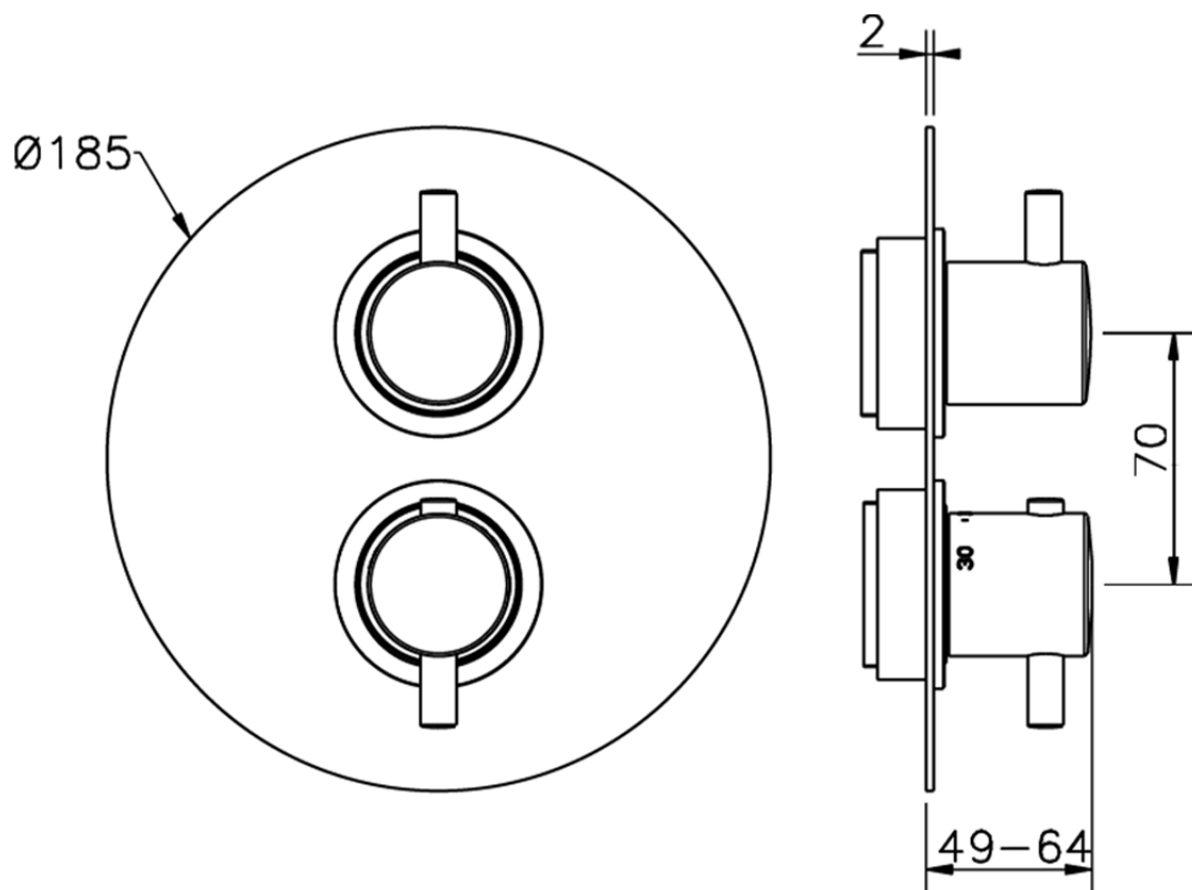

MT018200

<https://es.huberitalia.com/parte-externa-termostatico-empotrado-3-salidas-m32-mt018200>



Piastra/Plate/Plaque/Platte/Placa

2-3mm: XX 25-40 YY 76-91

10 mm: XX 16-31 YY 65-80

ZB018201

<https://es.huberitalia.com/parte-empotrada-termostatico-ducha-3-salidas-empotrado-zb018201>

2026-06-10