

Parte externa termostático ducha emp. 1 salida THERMO_MT007300

MODELO **MT007300**

Parte externa termostático ducha emp.1 salida, con llave de paso, sin parte empotrada, para art.ZB007301

ACABADOS DISPONIBLES

-  **21** 21 Cromo
-  **26** 26 Cobre Viejo
-  **2F** 2W Oro Cepillado
-  **2W** 2F Níquel Cepillado
-  **40** 40 Negro Mate
-  **4Q** 4Q Blanco Mate

CARACTERÍSTICAS

Instalación	Empotrado
Empotrado 1	ZB007301

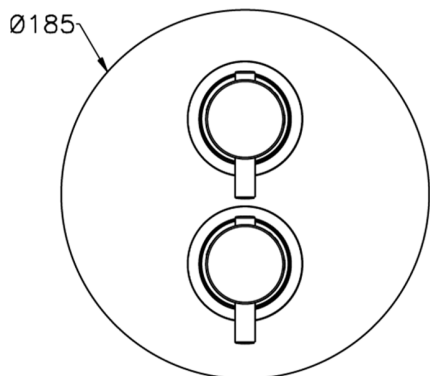

Termostático

El Termostático Huber es tu gestor personal del agua, ayudándote a manejar, controlar y ahorrar agua y energía.



Parte empotrada termostático ducha 1 salida EMPOTRADO_ZB007301
MODELO ZB007301

Parte empotrada termostático ducha 1 salida, con llave de paso, sin parte externa

ACABADOS DISPONIBLES

04 04 Sin Acabado

CARACTERÍSTICAS

Instalación	Empotrado
Recambio Cartucho	24.04A.PP
Cartucho Termostático Plus P 8X20	
Empotrado	1

Piastra/Plate/Plaque/Platte/Placa

2-3mm: XX 25-40 YY 76-91

10 mm: XX 16-31 YY 65-80

Termostático

El Termostático Huber es tu gestor personal del agua, ayudándote a manejar, controlar y ahorrar agua y energía.



2026-06-14