

Parte externa termostático empotrado 3 salidas M32_MT018200

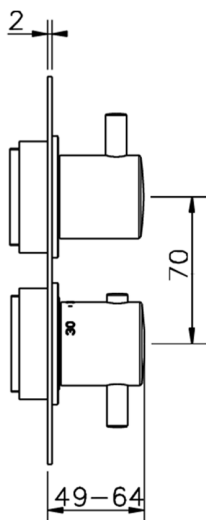
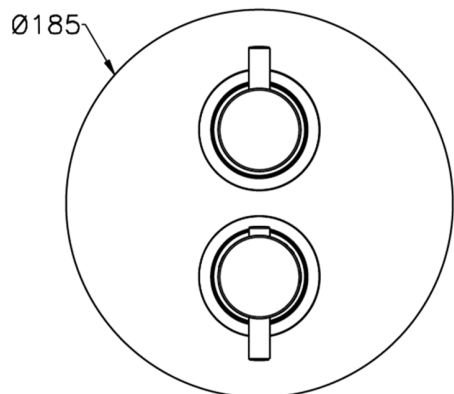

MODELO **MT018200**

Parte externa termostático empotrado 3 salidas, con deviasstop 3 salidas, sin parte empotrada, para art.ZB018201

ACABADOS DISPONIBLES

-  **21** 21 Cromo
-  **26** 26 Cobre Viejo
-  **2F** 2F Níquel Cepillado
-  **2W** 2W Oro Cepillado
-  **40** 40 Negro Mate
-  **4Q** 4Q Blanco Mate

CARACTERÍSTICAS

Instalación	Empotrado
Empotrado 1	ZB018201



Termostático

El Termostático Huber es tu gestor personal del agua, ayudándote a manejar, controlar y ahorrar agua y energía.



Parte empotrada termostático ducha 3 salidas EMPOTRADO_ZB018201

MODELO **ZB018201**

Parte empotrada termostático 3 salidas, con devia stop 3 salidas, sin parte externa

ACABADOS DISPONIBLES



04 04 Sin Acabado



CARACTERÍSTICAS

Instalación	Empotrado
Recambio Cartucho	24.04A.PP
Cartucho Termostático Plus P 8X20	
Empotrado	1



Piastra/Plate/Plaque/Platte/Placa
 2-3mm: XX 25-40 YY 76-91
 10 mm: XX 16-31 YY 65-80



DeviaStop

La tecnología Huber DeviaStop le permite ajustar el caudal de agua y dirigirla hacia la salida elegida (rociador superior, ducha de mano, etc.).



Termostático

El Termostático Huber es tu gestor personal del agua, ayudándote a manejar, controlar y ahorrar agua y energía.



2024-11-14