

Parte externa termostático ducha emp. 3 salidas HARLOCK_HC018200

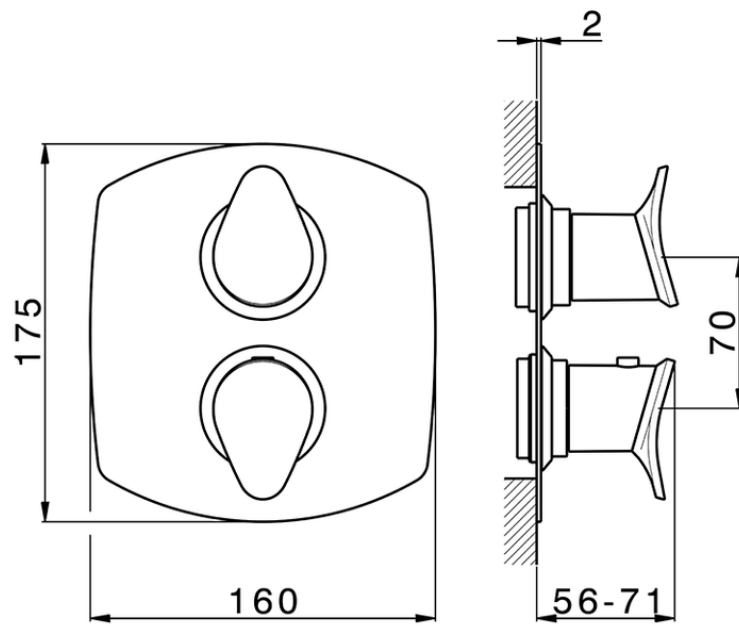

HC018200

<https://es.huberitalia.com/parte-externa-termostatico-ducha-emp-3-salidas-harlock-hc018200>



Piastra/Plate/Plaque/Platte/Placa

2-3mm: XX 25-40 YY 76-91

10 mm: XX 16-31 YY 65-80

ZB018200

<https://es.huberitalia.com/parte-empotrada-termostatico-ducha-3-salidas-empotrado-zb018200>

2026-06-15