

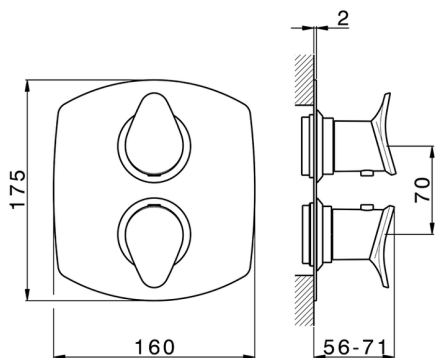

Parte externa termostático ducha emp. 1 salida THERMO_HC007300



MODELO **HC007300**

Parte externa termostático ducha emp.1 salida, con llave de paso, sin parte empotrada, para art.ZB007300

ACABADOS DISPONIBLES

-  **21** 21 Cromo
-  **2P** 2P Oro rosa
-  **2Q** 2Q Black Titanium
-  **40** 40 Negro Mate
-  **4Q** 4Q Blanco Mate
-  **6T** 6T Cromo/Negro Mate

CARACTERÍSTICAS

Instalación	Empotrado
Empotrado 1	ZB007300



Termostático

El Termostático Huber es tu gestor personal del agua, ayudándote a manejar, controlar y ahorrar agua y energía.



Parte empotrada termostático ducha 1 salida EMPOTRADO_ZB007300
MODELO ZB007300

Parte empotrada termostático ducha 1 salida, con llave de paso, sin parte externa

ACABADOS DISPONIBLES

04 04 Sin Acabado

CARACTERÍSTICAS

 Instalación **Empotrado**

 Recambio Cartucho **24.04A.PP**
Cartucho Termostático Plus P 8X20

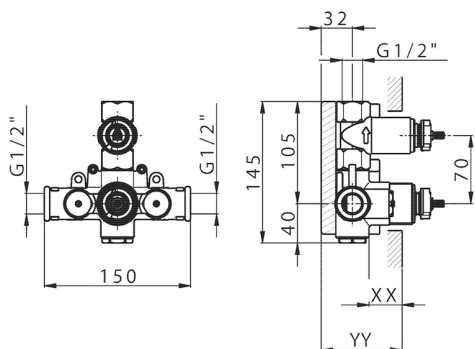
 Empotrado **1**

Piastra/Plate/Plaque/Platte/Placa

2-3mm: XX 25-40 YY 76-91

10 mm: XX 16-31 YY 65-80

Termostático

El Termostático Huber es tu gestor personal del agua, ayudándote a manejar, controlar y ahorrar agua y energía.



2025-12-07