





Parte externa termostático ducha emp. 3 salidas DADO_DD018200



MODELO **DD018200**

Parte externa termostático empotrado 3 salidas, con deviasstop 3 salidas, sin parte empotrada, para art. ZB018201

ACABADOS DISPONIBLES

-  **21** 21 Cromo
-  **2B** 2B Níquel Brillo
-  **2F** 2F Níquel Cepillado
-  **40** 40 Negro Mate
-  **4Q** 4Q Blanco Mate

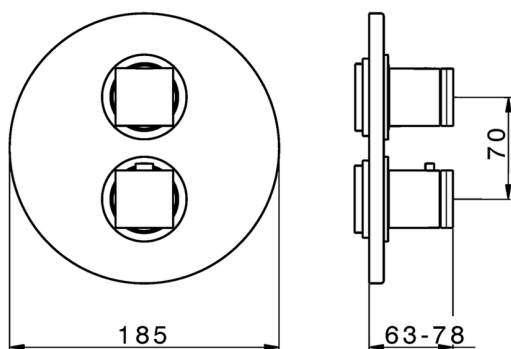

CARACTERÍSTICAS

Instalación **Empotrado**
 Empotrado 1 **ZB018201**



Termostático

El Termostático Huber es tu gestor personal del agua, ayudándote a manejar, controlar y ahorrar agua y energía.



Parte externa termostático ducha emp. 3 salidas DADO_DD018200

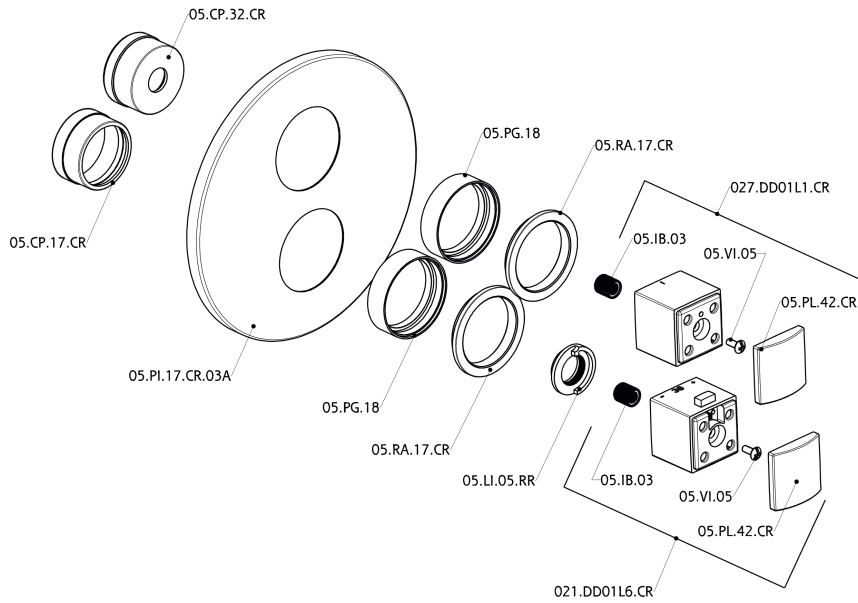

DD018200

<https://es.huberitalia.com/parte-externa-termostatico-ducha-emp-3-salidas-dado-dd018200>

Parte empotrada termostático ducha 3 salidas EMPOTRADO_ZB018201

MODELO **ZB018201**

Parte empotrada termostático 3 salidas, con devia stop 3 salidas, sin parte externa

ACABADOS DISPONIBLES



04 04 Sin Acabado

CARACTERÍSTICAS

Instalación **Empotrado**

Recambio Cartucho **24.04A.PP**

Cartucho Termostático Plus P 8X20

Empotrado **1**

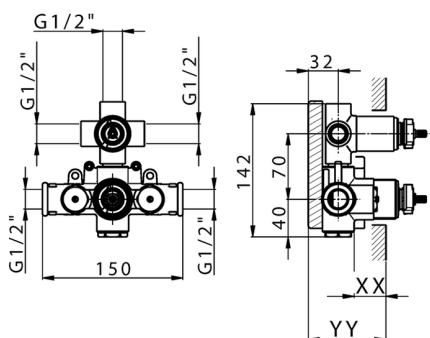

Piastra/Plate/Plaque/Platte/Placa

2-3mm: XX 25-40 YY 76-91

10 mm: XX 16-31 YY 65-80



DeviaStop

La tecnología Huber DeviaStop le permite ajustar el caudal de agua y dirigirla hacia la salida elegida (rociador superior, ducha de mano, etc.).



Termostático

El Termostático Huber es tu gestor personal del agua, ayudándote a manejar, controlar y ahorrar agua y energía.



2025-01-08