

Parte externa para termostático empotrado PUSH&SHOWER_PS0G1030



MODELO **PS0G1030**

Parte externa para termostático empotrado, sin parte empotrada, placa embellecedora cuadrada 80x80 mm, para empotrado termostático con caja de protección

ACABADOS DISPONIBLES

-  **21** 21 Cromo
-  **24** 24 Oro
-  **26** 26 Cobre Viejo
-  **2B** 2B Níquel Brillo
-  **2F** 2F Níquel Cepillado
-  **2W** 2W Oro Cepillado
-  **3W** 3W Brushed Black Titanium
-  **5G** 5G Oro Rosa
-  **40** 40 Negro Mate

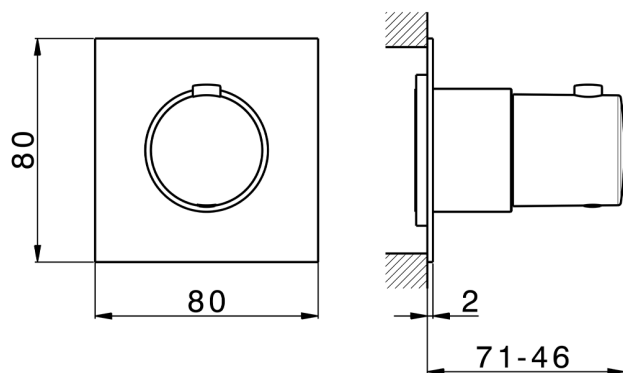

Termostático

El Termostático Huber es tu gestor personal del agua, ayudándote a manejar, controlar y ahorrar agua y energía.

CARACTERÍSTICAS

Instalación

Empotrado

Empotrado 1

ZB0G1000



2026-05-30