

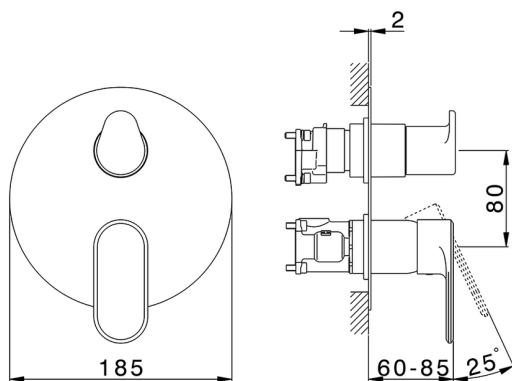





Conjunto Monomando para One-Box LEVITY_LY0BM030



MODELO **LY0BM030**

Conjunto Monomando para One-Box, con desviador 2-3 salidas, profundidad mínima de instalación 67 mm, sin parte empotrada, para art. ZB00B030-ZB00B031

ACABADOS DISPONIBLES

-  **21** 21 Cromo
-  **2B** 2B Níquel Brillo
-  **2F** 2F Níquel Cepillado
-  **40** 40 Negro Mate
-  **4Q** 4Q Blanco Mate

CARACTERÍSTICAS

Recambio Cartucho **ZZ97179000**

Cartucho Monomando 35 mm

Instalación **Empotrado**

Empotrado 2 **ZB00B031**

ZB00B030



Conjunto Monomando para One-Box LEVITY_LY0BM030

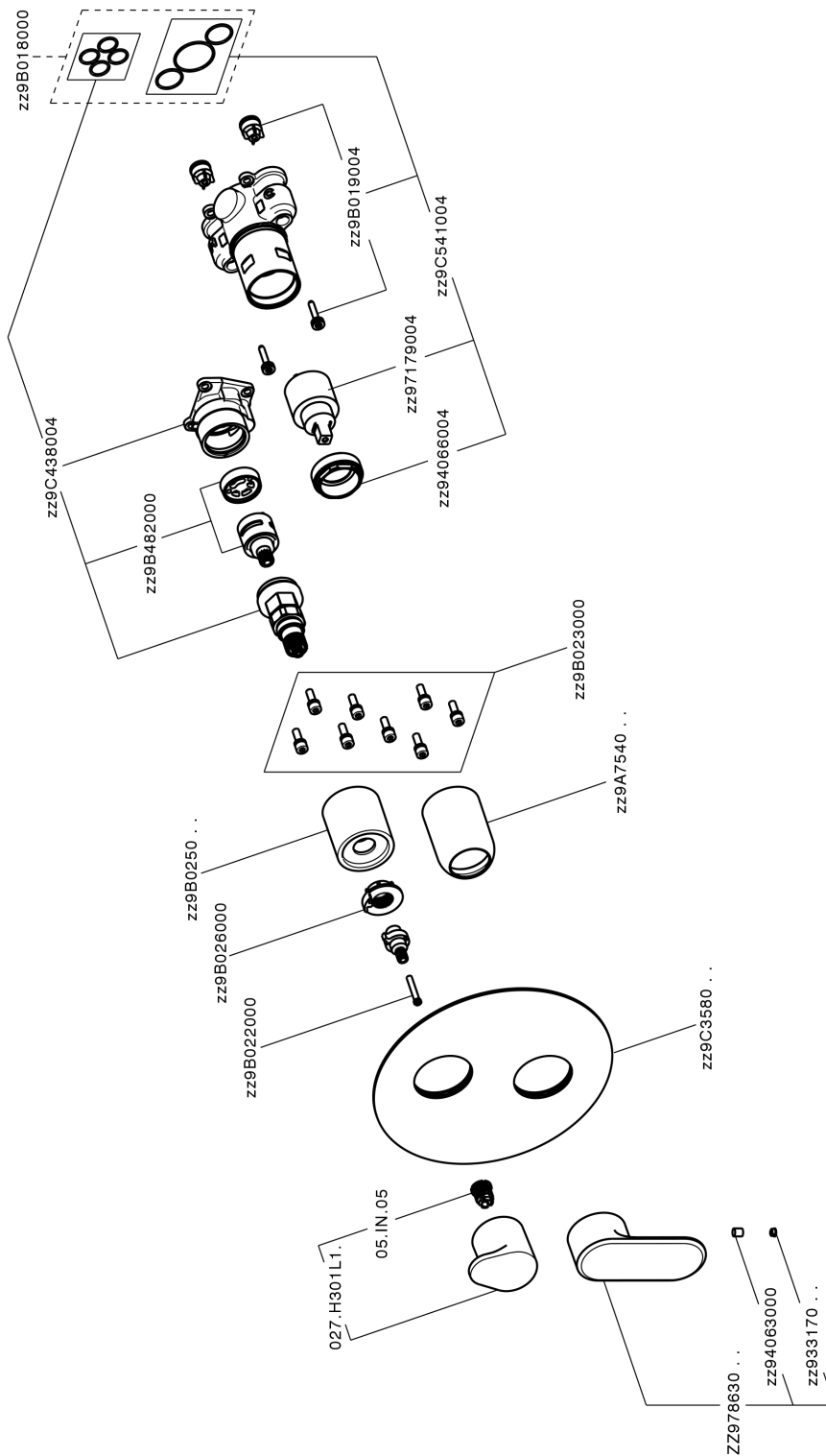

LY0BM030

<https://es.huberitalia.com/conjunto-monomando-para-one-box-levity-ly0bm030>

One-Box Universal para empotrado ONE BOX_ZB00B031



MODELO **ZB00B031**

One-Box Universal para empotrado, para termostático o monomando 1 o 2 o 3 salidas, sin parte externa, con silenciadores, con junta para sellado

ACABADOS DISPONIBLES



CARACTERÍSTICAS

Empotrado **1**
 Instalación **Empotrado**



Termostático

El Termostático Huber es tu gestor personal del agua, ayudándote a manejar, controlar y ahorrar agua y energía.



One-Box Universal para empotrado ONE BOX_ZB00B030



MODELO **ZB00B030**

One-Box Universal para empotrado, para termostático o monomando 1 o 2 o 3 salidas, sin parte externa, sin silenciadores, con junta para sellado

ACABADOS DISPONIBLES

 **04** 04 Sin Acabado

CARACTERÍSTICAS

Empotrado **1**
 Instalación **Empotrado**



Termostático

El Termostático Huber es tu gestor personal del agua, ayudándote a manejar, controlar y ahorrar agua y energía.



2024-12-22