

Toma de agua VICTORIAN_67.04H.

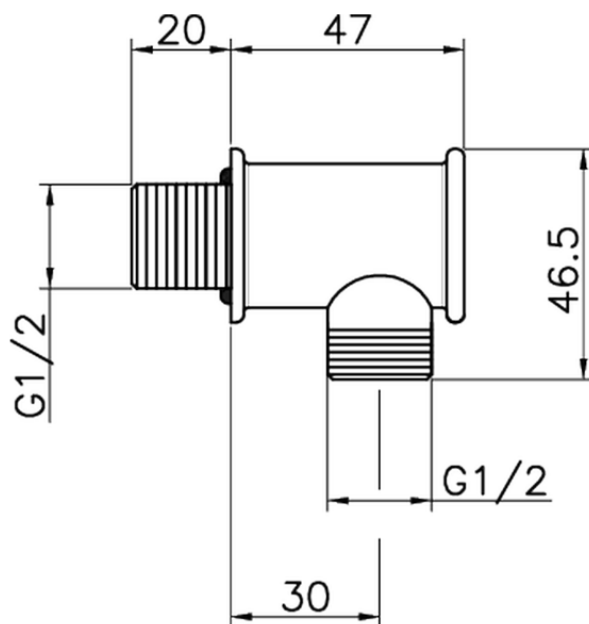

67.04H.

<https://es.huberitalia.com/toma-de-agua-victorian-67-04h>

2026-06-15