

Parte externa monomando lavabo de pared M32_MT005511

MODELO **MT005511**

Parte externa monomando lavabo de pared, sin parte empotrada, caño L.250 mm, para art. Easy-Box ZB002450 y art. ZB025510

ACABADOS DISPONIBLES

-  **21** 21 Cromo
-  **26** 26 Cobre Viejo
-  **2F** 2F Níquel Cepillado
-  **2W** 2W Oro Cepillado
-  **40** 40 Negro Mate
-  **4Q** 4Q Blanco Mate

CARACTERÍSTICAS

Instalación **Empotrado**
 Empotrado 1 **ZB002450**

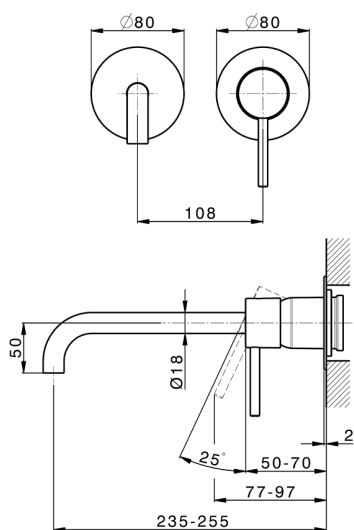

Parte empotrada monomando lavabo de pared Easy-Box EMPOTRADO_ZB002450

MODELO **ZB002450**

Parte empotrada monomando lavabo de pared Easy-Box, con caja de protección, sin parte externa

ACABADOS DISPONIBLES



CARACTERÍSTICAS

Instalación	Empotrado
Recambio Cartucho	ZZ95409000
Cartucho Monomando 35 mm	
Empotrado	1



Piastra/Plate/Plaque/Platte/Placa

2-3mm: XX 56-76

10mm: XX 48-68



DeviaStop

La tecnología Huber DeviaStop le permite ajustar el caudal de agua y dirigirla hacia la salida elegida (rociador superior, ducha de mano, etc.).



2026-05-02