

Ducha termostática con barra-corrediza VICTORIAN_190R.VT01H.

MODELO **190R.VT01H.**

Ducha termostática con barra-corrediza, barra corrediza con soporte deslizante 56 cm, duchita una función clásica de Latón D.78 mm, flexible Latón 150 cm

ACABADOS DISPONIBLES

-  **AC** AC Níquel Satinado Cepillado
-  **AG** AG Oro Viejo
-  **BA** BA Bronce Viejo
-  **CR** CR Cromo
-  **2W** 2W Oro Cepillado

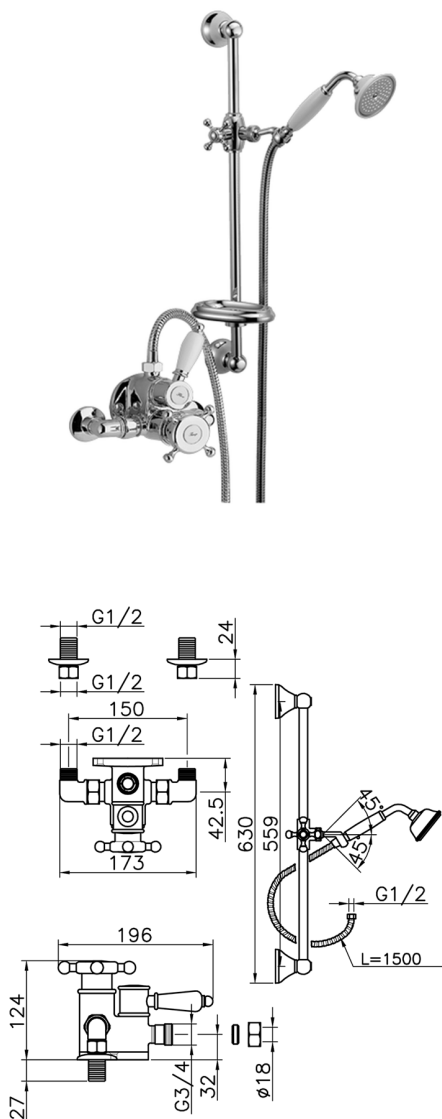

CARACTERÍSTICAS

Recambio Cartucho **24.04A.PP**

Cartucho Termostático Plus P 8X20



Termostático

El Termostático Huber es tu gestor personal del agua, ayudándote a manejar, controlar y ahorrar agua y energía.



2024-12-22