

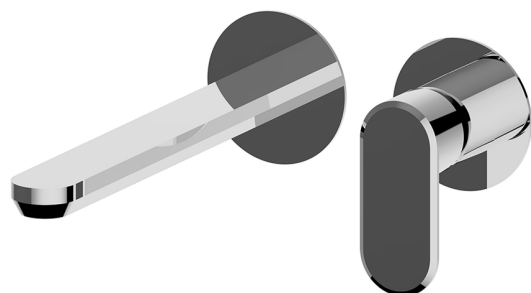





Parte externa monomando lavabo de pared LEVITY_LY005517

MODELO **LY005517**

Parte externa monomando lavabo de pared, sin parte empotrada, caño L.250 mm, para art. Easy-Box ZB002450 y art. ZB025510



ACABADOS DISPONIBLES

-  **21** 21 Cromo
-  **2B** 2B Níquel Brillo
-  **2F** 2F Níquel Cepillado
-  **40** 40 Negro Mate
-  **4Q** 4Q Blanco Mate

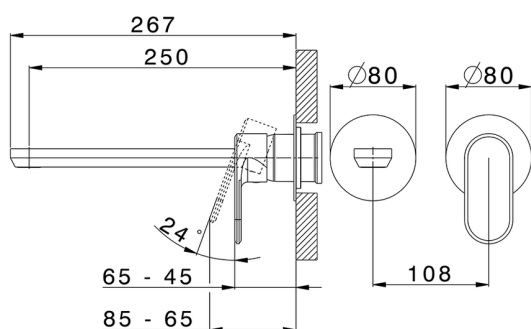

CARACTERÍSTICAS

Instalación	Empotrado
Empotrado 1	ZB002450



Parte esterna monomando lavabo de pared LEVITY_LY005517

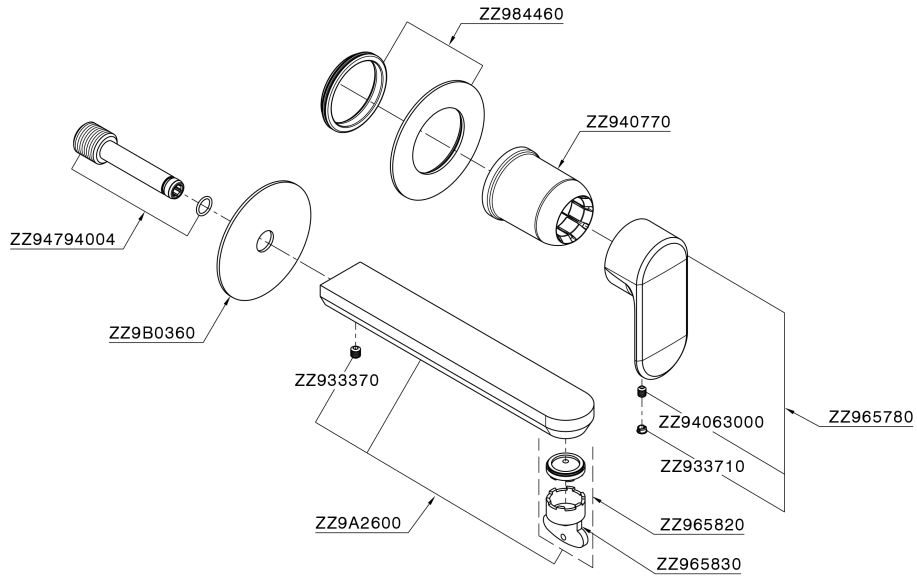

LY005517

<https://es.huberitalia.com/parte-externa-monomando-lavabo-de-pared-levity-ly005517>

Parte empotrada monomando lavabo de pared Easy-Box EMPOTRADO_ZB002450

MODELO **ZB002450**

Parte empotrada monomando lavabo de pared Easy-Box, con caja de protección, sin parte externa

ACABADOS DISPONIBLES



CARACTERÍSTICAS

Empotrado **1**
 Recambio Cartucho **ZZ95409000**
Cartucho Monomando 35 mm



Piastra/Plate/Plaque/Platte/Placa

2-3mm: XX 56-76

10mm: XX 48-68



EcoStop

La función EcoStop limita el caudal del agua aproximadamente el 50% de la salida máxima con una leve resistencia en la maneta. Basta con empujar ligeramente más allá de la mitad del tope sólo cuando se requiera la salida máxima de agua. Esto permitirá ahorrar hasta un 50% de agua.



2024-11-23