







## Brazo ducha SHOWER\_SS013390

MODELO **SS013390**

Brazo ducha, L.300 mm D.20,5 mm, Latón

ACABADOS DISPONIBLES

-  **21** 21 Cromo
-  **2B** 2B Níquel Brillo
-  **2F** 2F Níquel Cepillado
-  **2P** 2P Oro rosa
-  **40** 40 Negro Mate
-  **4Q** 4Q Blanco Mate
-  **2W** 2W Oro Cepillado

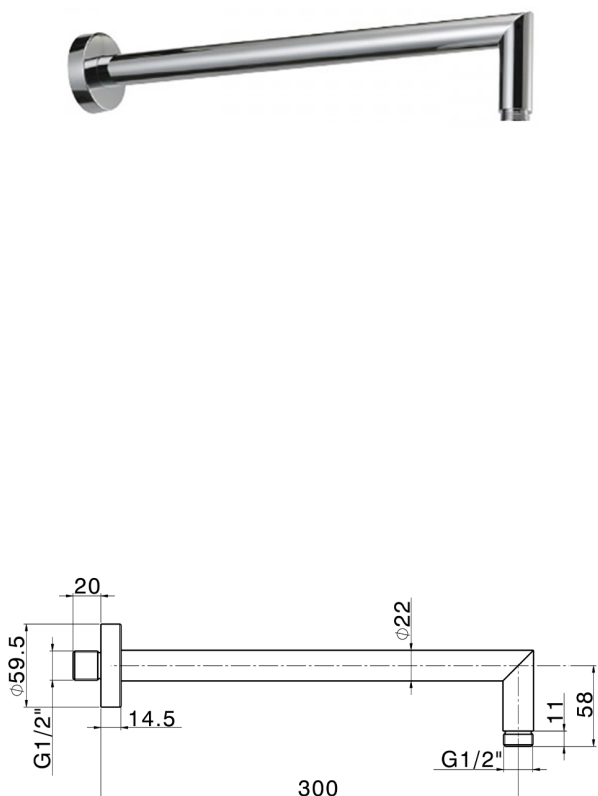

CARACTERÍSTICAS



2024-11-21