

## Parte externa termostático ducha emp. 1 salida THERMO\_K2007300

MODELO **K2007300**

Parte externa termostático ducha emp.1 salida, con llave de paso, sin parte empotrada, para art.ZB007301

### ACABADOS DISPONIBLES

-  **21** 21 Cromo
-  **26** 26 Cobre Viejo
-  **2F** 2W Oro Cepillado
-  **2W** 2F Níquel Cepillado
-  **40** 40 Negro Mate
-  **4Q** 4Q Blanco Mate

### CARACTERÍSTICAS

Instalación **Empotrado**  
Empotrado 1 **ZB007301**

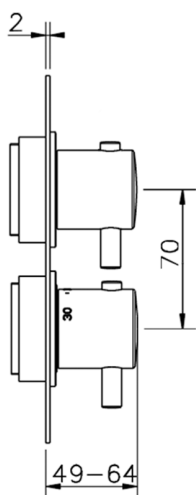
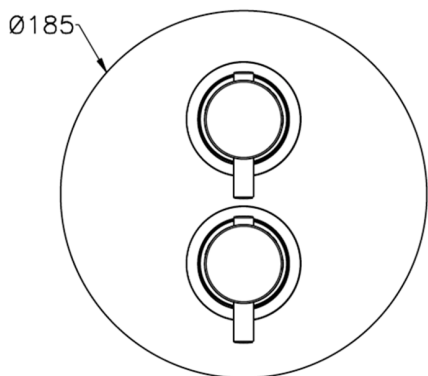

### Termostático

El Termostático Huber es tu gestor personal del agua, ayudándote a manejar, controlar y ahorrar agua y energía.



**Parte empotrada termostático ducha 1 salida EMPOTRADO\_ZB007301**
**MODELO ZB007301**

Parte empotrada termostático ducha 1 salida, con llave de paso, sin parte externa

**ACABADOS DISPONIBLES**

**04** 04 Sin Acabado

**CARACTERÍSTICAS**

Instalación	<b>Empotrado</b>
Recambio Cartucho	<b>24.04A.PP</b>
<b>Cartucho Termostático Plus P 8X20</b>	
Empotrado	<b>1</b>

**Piastra/Plate/Plaque/Platte/Placa**

2-3mm: XX 25-40 YY 76-91

10 mm: XX 16-31 YY 65-80

**Termostático**

El Termostático Huber es tu gestor personal del agua, ayudándote a manejar, controlar y ahorrar agua y energía.



2026-04-12