



## Parte externa termostático ducha emp. 2 salidas SUITE\_SU018100



MODELO **SU018100**

Parte externa termostático empotrado 2 salidas, con devias top, sin parte empotrada, para art. ZB018101

### ACABADOS DISPONIBLES

-  **21** 21 Cromo
-  **40** 40 Negro Mate
-  **2F** 2F Níquel Cepillado
-  **2W** 2W Oro Cepillado

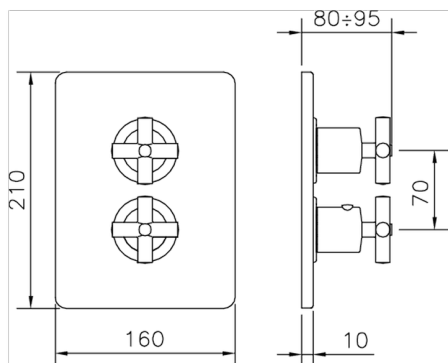

### CARACTERÍSTICAS

Instalación **Empotrado**  
 Empotrado 1 **ZB018101**



### Termostático

El Termostático Huber es tu gestor personal del agua, ayudándote a manejar, controlar y ahorrar agua y energía.



## Parte externa termostático ducha emp. 2 salidas SUITE\_SU018100

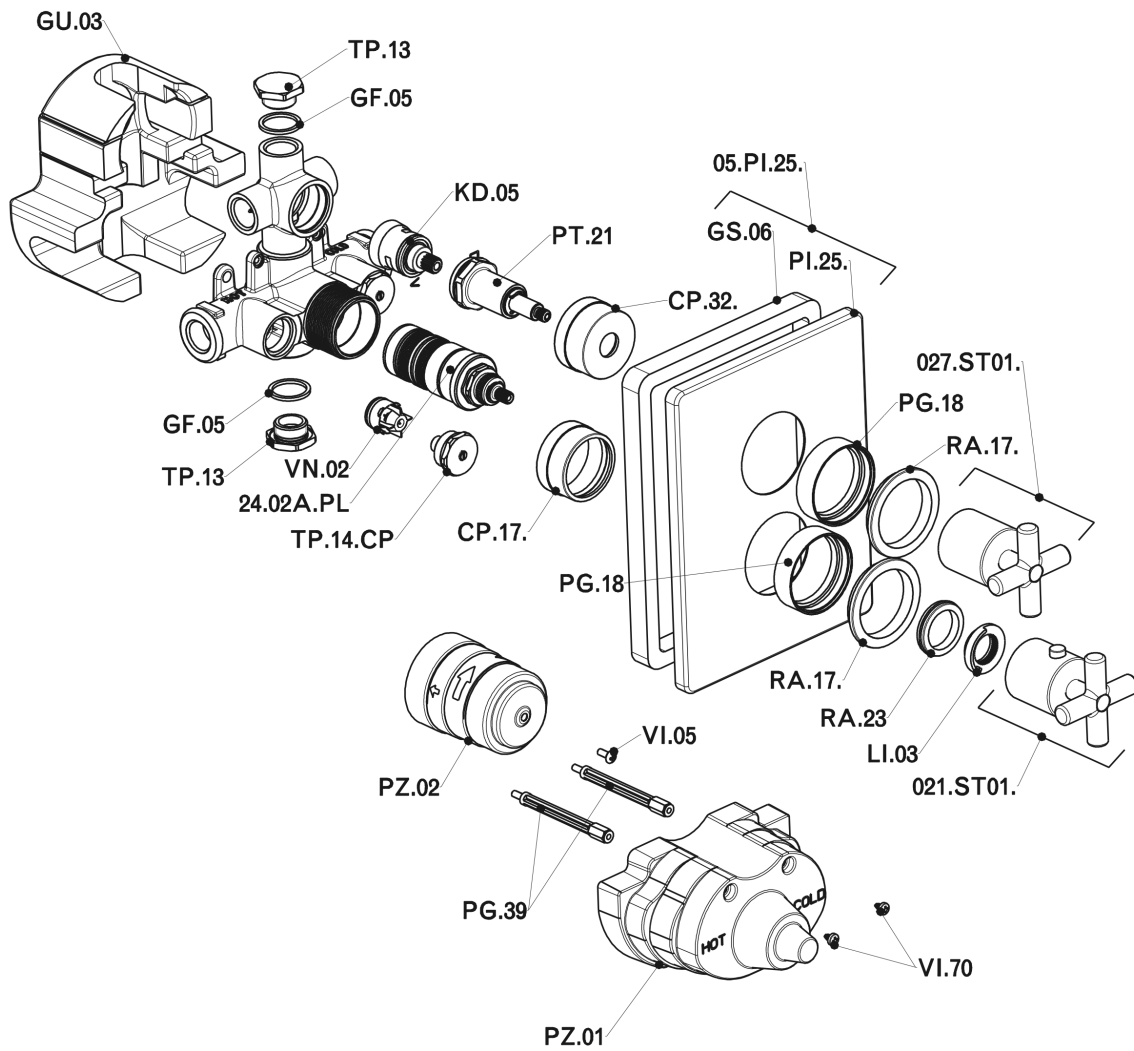

SU018100

<https://es.huberitalia.com/parte-externa-termostatico-ducha-emp-2-salidas-suite-su018100>

## Parte empotrada termostático ducha 2 salidas EMPOTRADO\_ZB018101

MODELO **ZB018101**

Parte empotrada termostático 2 salidas, con devia stop 2 salidas, sin parte externa

ACABADOS DISPONIBLES



**04** 04 Sin Acabado



CARACTERÍSTICAS

Instalación	<b>Empotrado</b>
Recambio Cartucho	<b>24.04A.PP</b>
	<b>Cartucho Termostático Plus P 8X20</b>
Empotrado	<b>1</b>

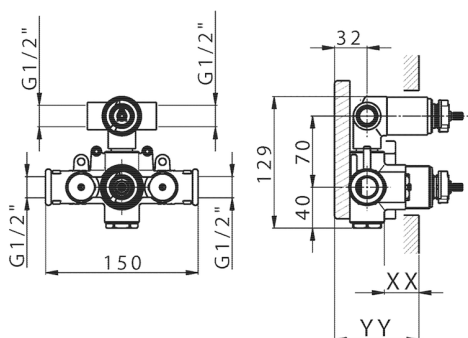

Piastra/Plate/Plaque/Platte/Placa

2-3mm: XX 25-40 YY 76-91

10 mm: XX 16-31 YY 65-80



### DeviaStop

La tecnología Huber DeviaStop le permite ajustar el caudal de agua y dirigirla hacia la salida elegida (rociador superior, ducha de mano, etc.).



### Termostático

El Termostático Huber es tu gestor personal del agua, ayudándote a manejar, controlar y ahorrar agua y energía.



2024-11-24