

## Parte empotrada termostático ducha 1 salida EMPOTRADO\_ZB007301

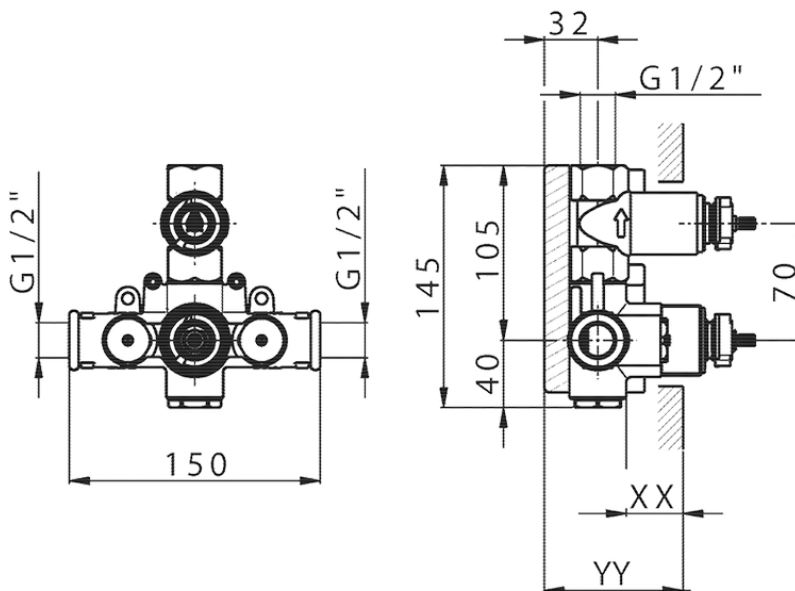

Piastra/Plate/Plaque/Platte/Placa  
 2-3mm: XX 25-40 YY 76-91  
 10 mm: XX 16-31 YY 65-80

ZB007301

<https://es.huberitalia.com/parte-empotrada-termostatico-ducha-1-salida-empotrado-zb007301>

2026-05-20