

Parte externa lavabo de pared NUOVA KIRUNA_K2013512

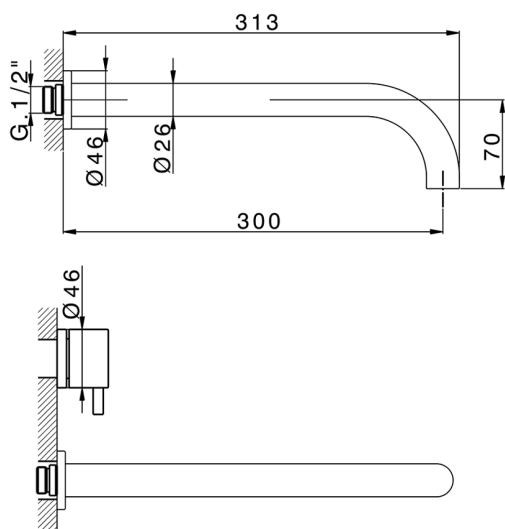

MODELO **K2013512**

Parte externa lavabo de pared, sin parte empotrada, caño L.300 mm, para art. ZB033511

ACABADOS DISPONIBLES

-  **21** 21 Cromo
-  **26** 26 Cobre Viejo
-  **2F** 2F Níquel Cepillado
-  **2W** 2W Oro Cepillado
-  **40** 40 Negro Mate
-  **4Q** 4Q Blanco Mate

CARACTERÍSTICAS

Instalación	Empotrado
Empotrado 1	ZB033511



Parte empotrada lavabo de pared EMPOTRADO_ZB033511

MODELO **ZB033511**

Parte empotrada lavabo de pared, con montura de derecha y montura de izquierda

ACABADOS DISPONIBLES



04 04 Sin Acabado

CARACTERÍSTICAS

Instalación **Empotrado**

Empotrado **1**

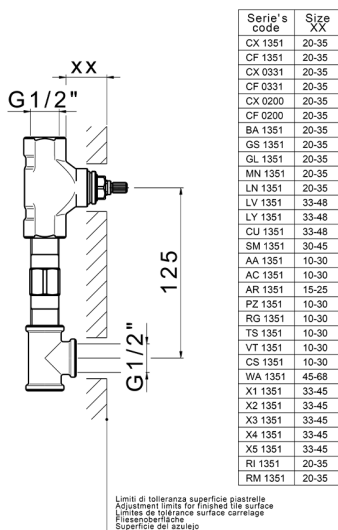

2026-06-13