

Parte externa termostático ducha emp. 2 salidas CHRONOS_CR019140



MODELO **CR019140**

Parte externa termostático ducha emp.2 salidas,con deviasstop 2 salidas,sin parte empotrada,para art.ZB019140

ACABADOS DISPONIBLES

-  **21** 21 Cromo
-  **2F** 2F Níquel Cepillado
-  **2Q** 2Q Black Titanium

CARACTERÍSTICAS

Instalación **Empotrado**
Empotrado 1 **ZB019140**

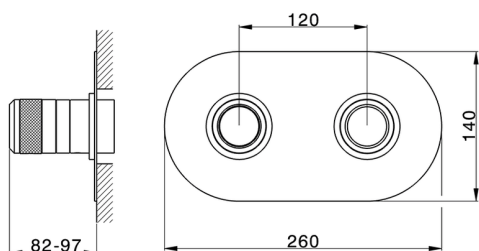

Termostático

El Termostático Huber es tu gestor personal del agua, ayudándote a manejar, controlar y ahorrar agua y energía.



Parte empotrada termostático ducha 2 salidas EMPOTRADO_ZB019140

MODELO **ZB019140**

Parte empotrada termostático ducha 2 salidas, sin parte externa

ACABADOS DISPONIBLES



04 04 Sin Acabado



CARACTERÍSTICAS

Instalación **Empotrado**

Recambio Cartucho **24.04A.PP**

Cartucho Termostático Plus P 8X20

Empotrado **1**

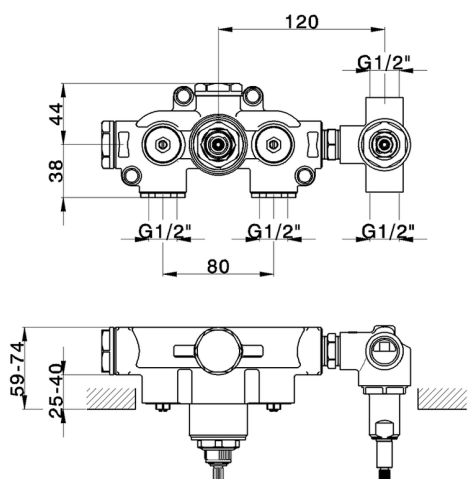

Termostático

El Termostático Huber es tu gestor personal del agua, ayudándote a manejar, controlar y ahorrar agua y energía.



2025-01-31