

## Bañera monomando con duplex NORMA\_NM000120

MODELO **NM000120**

Bañera monomando con duplex, soporte duchita articulado mural, duchita Teti 3 funciones de ABS, flexible de Latón 150 cm

ACABADOS DISPONIBLES



CARACTERÍSTICAS

Recambio Cartucho **ZZ94034000**

**Cartucho Monomando 35 mm**

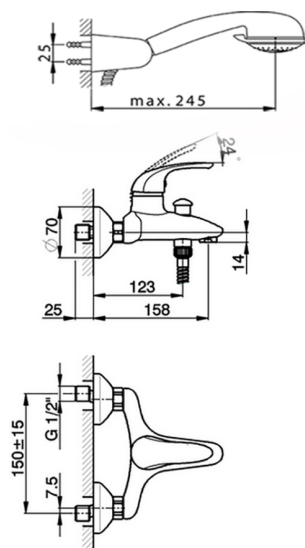

2025-01-21