

Parte externa termostático ducha emp. 1 salida THERMO_CS007280



MODELO **CS007280**

Parte externa termostático ducha emp.1 salida,llave de paso,sin parte empotrada,para art.ZB007281-ZB007341

ACABADOS DISPONIBLES

-  **21** 21 Cromo
-  **27** 27 Bronce Viejo
-  **2G** 2G Oro Viejo
-  **2W** 2W Oro Cepillado

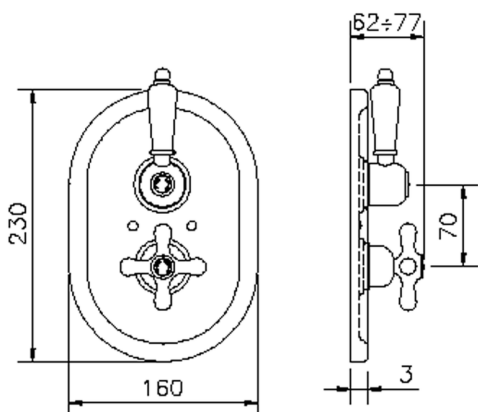

CARACTERÍSTICAS

Instalación **Empotrado**
 Empotrado 2 **ZB007341**
ZB007281



Termostático

El Termostático Huber es tu gestor personal del agua, ayudándote a manejar, controlar y ahorrar agua y energía.



Parte externa termostático ducha emp. 1 salida THERMO_CS007280

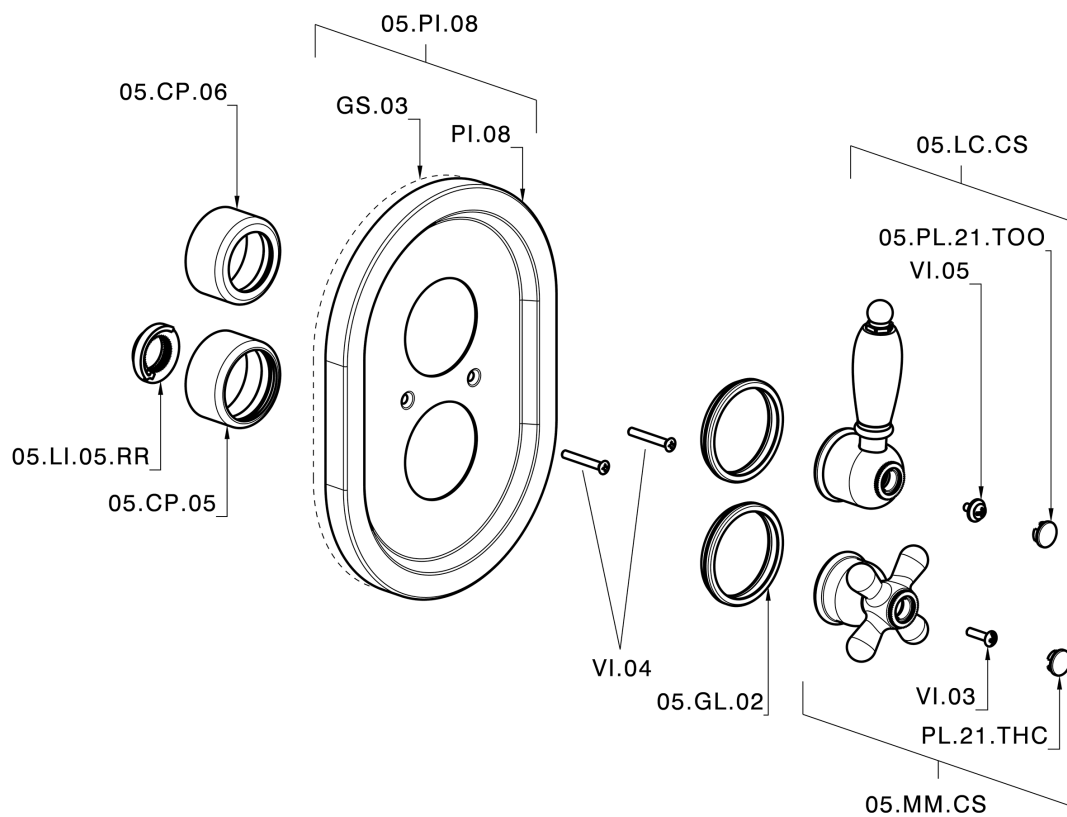

CS007280

<https://es.huberitalia.com/parte-externa-termostatico-ducha-emp-1-salida-thermo-cs007280>

Parte empotrada termostático ducha 1 salida EMPOTRADO_ZB007341

MODELO **ZB007341**

Parte empotrada termostático ducha 1 salida, llave de paso con salida 3/4", sin parte externa

ACABADOS DISPONIBLES



04 04 Sin Acabado



CARACTERÍSTICAS

Instalación **Empotrado**

Recambio Cartucho **23.51A.HF**

Cartucho Termostático HF

Empotrado **1**

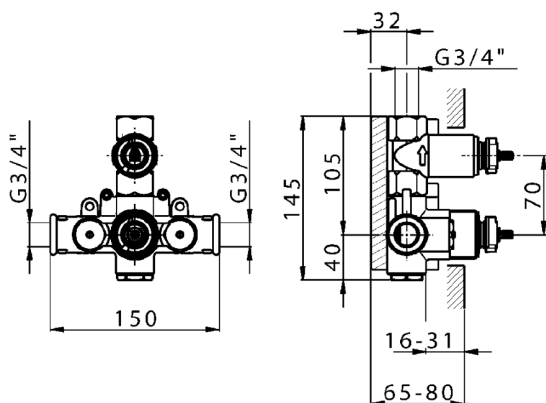

Termostático

El Termostático Huber es tu gestor personal del agua, ayudándote a manejar, controlar y ahorrar agua y energía.



Parte empotrada termostático ducha 1 salida EMPOTRADO_ZB007281

MODELO **ZB007281**

Parte empotrada termostático ducha 1 salida, llave de paso con salida 1/2", sin parte externa

ACABADOS DISPONIBLES



04 04 Sin Acabado



CARACTERÍSTICAS

Instalación **Empotrado**

Recambio Cartucho **24.04A.PP**

Cartucho Termostático Plus P 8X20

Empotrado **1**

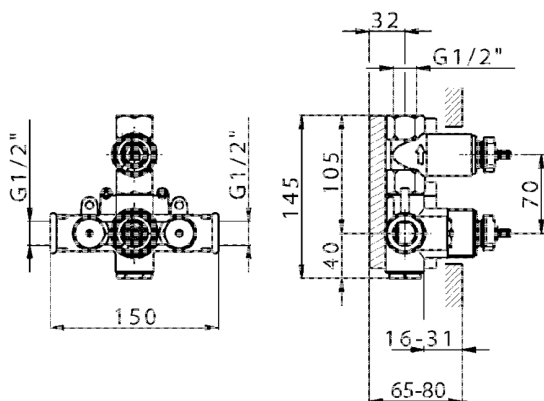

Termostático

El Termostático Huber es tu gestor personal del agua, ayudándote a manejar, controlar y ahorrar agua y energía.



2024-12-22