

Parte externa para Push&Shower individual PUSH&SHOWER_PS0G6320

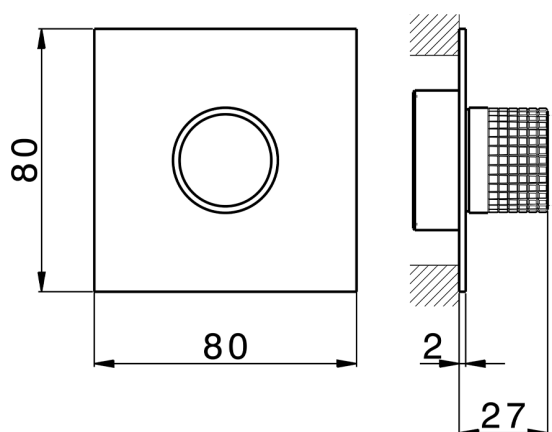
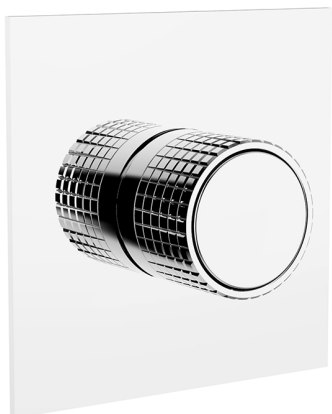

MODELO **PS0G6320**

Parte externa para Push&Shower individual, pulsador con diseño cuadrículado, placa embellecedora cuadrada 80x80 mm, para empotrado Push&Shower

ACABADOS DISPONIBLES

-  **21** 21 Cromo
-  **24** 24 Oro
-  **26** 26 Cobre Viejo
-  **2B** 2B Níquel Brillo
-  **2F** 2F Níquel Cepillado
-  **2W** 2W Oro Cepillado
-  **3W** 3W Brushed Black Titanium
-  **5G** 5G Oro Rosa
-  **40** 40 Negro Mate



Termostático

El Termostático Huber es tu gestor personal del agua, ayudándote a manejar, controlar y ahorrar agua y energía.

CARACTERÍSTICAS

Instalación **Empotrado**
Empotrado 1 **ZB0G6000**



Parte empotrada Push&Shower EMPOTRADO_ZB0G6000

MODELO **ZB0G6000**

Parte empotrada Push&Shower, con pulsador ON/OFF con regulación de caudal, con caja de protección, combinar con parte externa Push&Shower, sin parte externa



ACABADOS DISPONIBLES

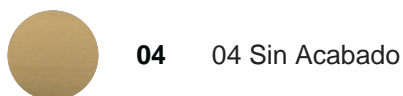

CARACTERÍSTICAS

Cartucho Termostático Argo 2 (filtro lungo)

Empotrado **1**



2024-11-21