

Parte externa monomando ducha empotrada M32_MT003000

MODELO **MT003000**

Parte externa monomando ducha empotrada, sin parte empotrada, para art. ZB005300-ZB005301

ACABADOS DISPONIBLES

-  **21** 21 Cromo
-  **26** 26 Cobre Viejo
-  **2F** 2F Níquel Cepillado
-  **2W** 2W Oro Cepillado
-  **40** 40 Negro Mate
-  **4Q** 4Q Blanco Mate

CARACTERÍSTICAS

Instalación	Empotrado
Empotrado 2	ZB005301
	ZB005300

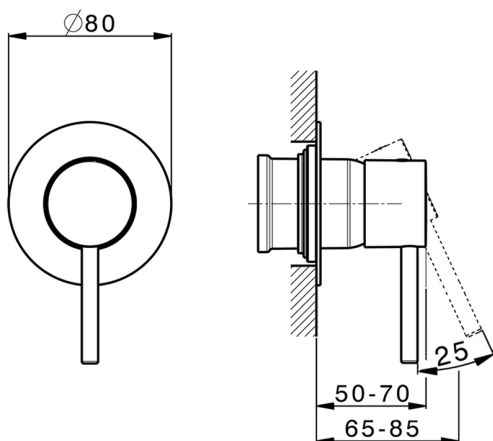

Parte empotrada monomando ducha EMPOTRADO_ZB005301

MODELO **ZB005301**

Parte empotrada monomando ducha, ducha empotrada 1/2", sin parte externa, con silenciadores

ACABADOS DISPONIBLES



04 04 Sin Acabado



CARACTERÍSTICAS

Instalación	Empotrado
Recambio Cartucho	ZZ94035000
Cartucho Monomando 35 mm	
Empotrado	1



Piastra/Plate/Plaque/Platte/Placa
 2-3mm: XX 27-47 YY 54-74
 10mm: XX 16-40 YY 43-68



Parte empotrada monomando ducha EMPOTRADO_ZB005300

MODELO **ZB005300**

Parte empotrada monomando ducha, ducha empotrada 1/2", sin parte externa

ACABADOS DISPONIBLES



04 04 Sin Acabado



CARACTERÍSTICAS

Instalación	Empotrado
Recambio Cartucho	ZZ94035000
Cartucho Monomando 35 mm	
Empotrado	1



Piastra/Plate/Plaque/Platte/Placa
 2-3mm: XX 27-47 YY 54-74
 10mm: XX 16-40 YY 43-68



2026-06-10