

Parte empotrada monomando free-standing EMPOTRADO\_ZB004510

MODELO **ZB004510**

Parte empotrada de suelo, para monomando free-standing

ACABADOS DISPONIBLES

 **04** 04 Sin Acabado

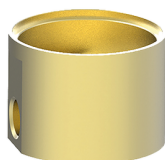

CARACTERÍSTICAS

Instalación	<b>Empotrado</b>
Empotrado	<b>1</b>

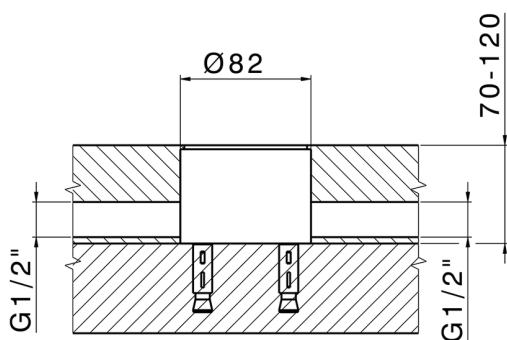

2026-04-10