

## Parte externa para termostático empotrado PUSH&SHOWER\_PS0G1010

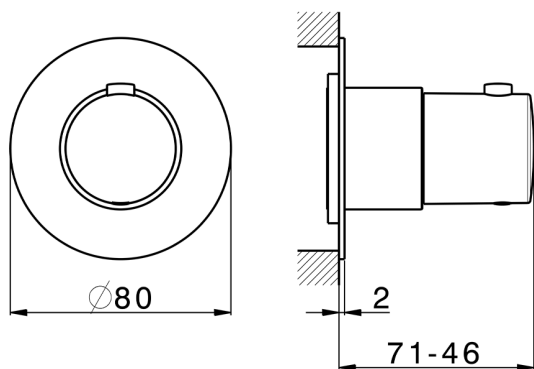

MODELO **PS0G1010**

Parte externa para termostático empotrado, sin parte empotrada, placa embellecedora redonda Ø80 mm, para empotrado termostático con caja de protección

### ACABADOS DISPONIBLES

-  **21** 21 Cromo
-  **24** 24 Oro
-  **26** 26 Cobre Viejo
-  **2B** 2B Níquel Brillo
-  **2F** 2F Níquel Cepillado
-  **2W** 2W Oro Cepillado
-  **3W** 3W Brushed Black Titanium
-  **5G** 5G Oro Rosa
-  **40** 40 Negro Mate



### Termostático

El Termostático Huber es tu gestor personal del agua, ayudándote a manejar, controlar y ahorrar agua y energía.

### CARACTERÍSTICAS

Instalación

**Empotrado**

Empotrado 1

**ZB0G1000**



## Parte empotrada termostático EMPOTRADO\_ZB0G1000

MODELO **ZB0G1000**

Parte empotrada termostático, sin llave de paso, con caja de protección, combinar con parte externa termostática, sin parte externa



ACABADOS DISPONIBLES

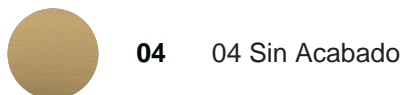

CARACTERÍSTICAS

Recambio Cartucho **22.04A.AR - ZZ97279004**

**Cartucho Termostático Argo 2 (filtro lungo)**

Empotrado **1**

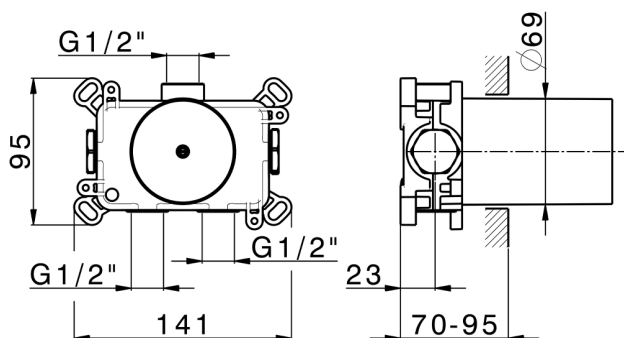

### Termostático

El Termostático Huber es tu gestor personal del agua, ayudándote a manejar, controlar y ahorrar agua y energía.



2024-11-23