

## Bidé monomando NUOVA KIRUNA\_K2000550

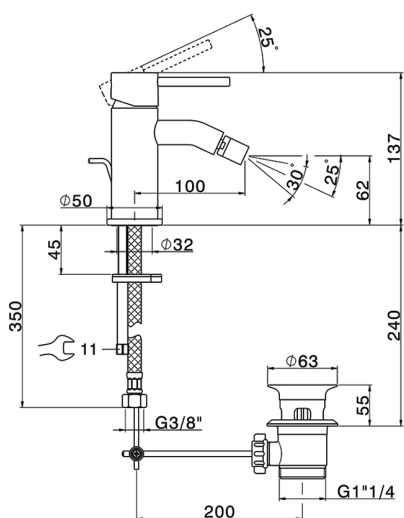

MODELO **K2000550**

Bidé monomando, con desagüe automático  
1"1/4, latiguillos acero G.3/8"

### ACABADOS DISPONIBLES

-  **21** 21 Cromo
-  **26** 26 Cobre Viejo
-  **2F** 2F Níquel Cepillado
-  **2W** 2W Oro Cepillado
-  **40** 40 Negro Mate
-  **4Q** 4Q Blanco Mate

### CARACTERÍSTICAS

Recambio Cartucho **ZZ99672000**

**Cartucho Monomando 35 mm**



### EcoStop

La función EcoStop limita el caudal del agua aproximadamente el 50% de la salida máxima con una leve resistencia en la maneta. Basta con empujar ligeramente más allá de la mitad del tope sólo cuando se requiera la salida máxima de agua. Esto permitirá ahorrar hasta un 50% de agua.



## Bidé monomando NUOVA KIRUNA\_K2000550

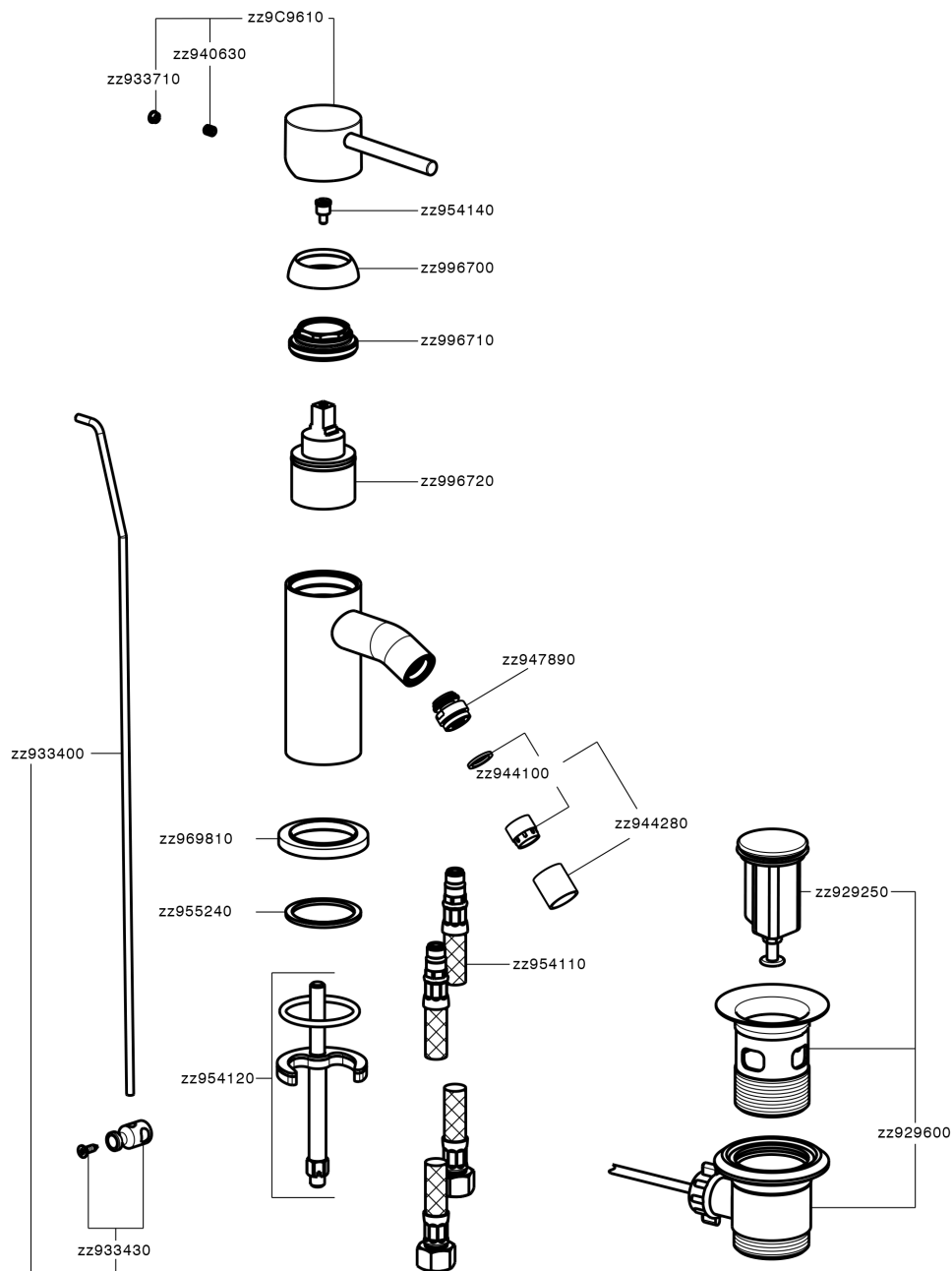

K2000550

<https://es.huberitalia.com/bide-monomando-nuova-kiruna-k2000550>

2024-11-23