

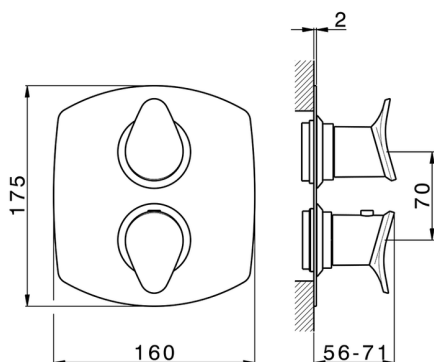

Parte externa termostático ducha emp. 2 salidas HARLOCK_HC018100



MODELO **HC018100**

Parte externa termostático empotrado 2 salidas, con deviasstop 2 salidas, sin parte empotrada, para art.ZB018100

ACABADOS DISPONIBLES

-  **21** 21 Cromo
-  **2P** 2P Oro rosa
-  **2Q** 2Q Black Titanium
-  **40** 40 Negro Mate
-  **4Q** 4Q Blanco Mate
-  **6T** 6T Cromo/Negro Mate

CARACTERÍSTICAS

Instalación	Empotrado
Empotrado 1	ZB018100



Termostático

El Termostático Huber es tu gestor personal del agua, ayudándote a manejar, controlar y ahorrar agua y energía.



Parte empotrada termostático ducha 2 salidas EMPOTRADO_ZB018100

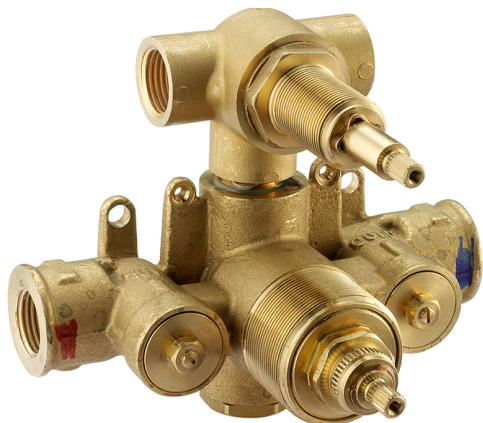

MODELO **ZB018100**

Parte empotrada termostático 2 salidas, con devia stop 1/2", sin parte externa

ACABADOS DISPONIBLES

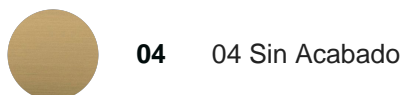

CARACTERÍSTICAS

Instalación	Empotrado
Recambio Cartucho	24.04A.PP
Cartucho Termostático Plus P 8X20	
Empotrado	1



Piastra/Plate/Plaque/Platte/Placa

2-3mm: XX 25-40 YY 76-91

10 mm: XX 16-31 YY 65-80



DeviaStop

La tecnología Huber DeviaStop le permite ajustar el caudal de agua y dirigirla hacia la salida elegida (rociador superior, ducha de mano, etc.).



Termostático

El Termostático Huber es tu gestor personal del agua, ayudándote a manejar, controlar y ahorrar agua y energía.



2025-01-21