

## Parte externa monomando lavabo de pared M32\_MT005510

MODELO **MT005510**

Parte externa monomando lavabo de pared, sin parte empotrada, caño L.200 mm, para art. Easy-Box ZB002450 y art. ZB025510

### ACABADOS DISPONIBLES

-  **21** 21 Cromo
-  **26** 26 Cobre Viejo
-  **2F** 2F Níquel Cepillado
-  **2W** 2W Oro Cepillado
-  **40** 40 Negro Mate
-  **4Q** 4Q Blanco Mate

### CARACTERÍSTICAS

Instalación	<b>Empotrado</b>
Empotrado 1	<b>ZB002450</b>

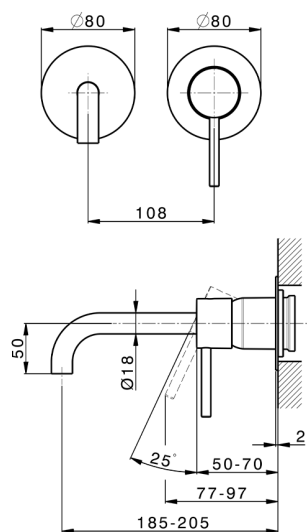
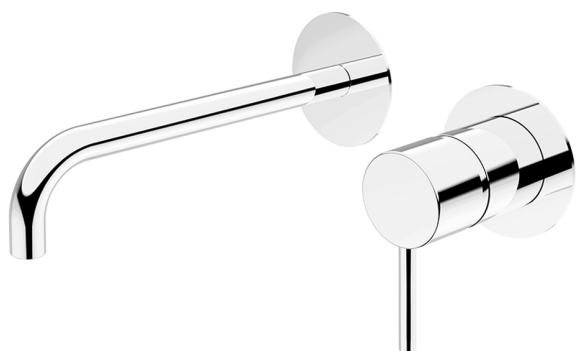

## Parte empotrada monomando lavabo de pared Easy-Box EMPOTRADO\_ZB002450

MODELO **ZB002450**

Parte empotrada monomando lavabo de pared Easy-Box, con caja de protección, sin parte externa

ACABADOS DISPONIBLES



CARACTERÍSTICAS

Instalación	<b>Empotrado</b>
Recambio Cartucho	<b>ZZ95409000</b>
<b>Cartucho Monomando 35 mm</b>	
Empotrado	<b>1</b>



Piastra/Plate/Plaque/Platte/Placa

2-3mm: XX 56-76

10mm: XX 48-68



### DeviaStop

La tecnología Huber DeviaStop le permite ajustar el caudal de agua y dirigirla hacia la salida elegida (rociador superior, ducha de mano, etc.).



2026-06-13