

## Parte externa termostático ducha empotrada THERMO\_VT007200

MODELO **VT007200**

Parte externa termostático ducha empotrada, sin llave de paso, sin parte empotrada, para art. ZB007201-ZB007221

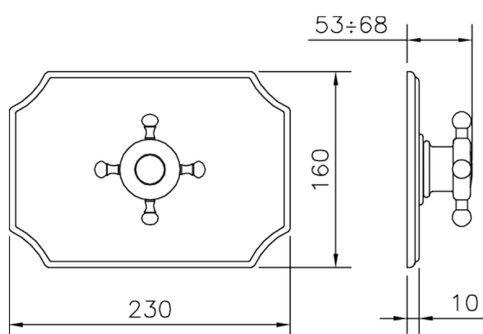
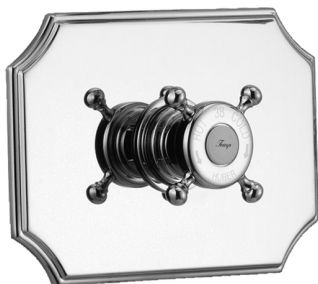

### ACABADOS DISPONIBLES

-  **21** 21 Cromo
-  **27** 27 Bronce Viejo
-  **2A** 2A Niquel Satinado Cepillado
-  **2G** 2G Oro Viejo
-  **2W** 2W Oro Cepillado

### CARACTERÍSTICAS

Instalación	<b>Empotrado</b>
Empotrado 1	<b>ZB007201</b>



### Termostático

El Termostático Huber es tu gestor personal del agua, ayudándote a manejar, controlar y ahorrar agua y energía.



## Parte empotrada termostático ducha 1/2" EMPOTRADO\_ZB007201

MODELO **ZB007201**

Parte empotrada termostático ducha 1/2", sin llave de paso, sin parte externa

ACABADOS DISPONIBLES



**04** 04 Sin Acabado



CARACTERÍSTICAS

Instalación **Empotrado**

Recambio Cartucho **24.04A.PP**

**Cartucho Termostático Plus P 8X20**

Empotrado **1**

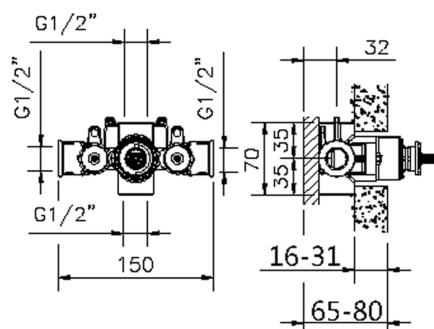

### Termostático

El Termostático Huber es tu gestor personal del agua, ayudándote a manejar, controlar y ahorrar agua y energía.



2024-12-04