





Parte externa termostático ducha empotrada NUOVA EGO_NE007200

MODELO **NE007200**

Parte externa termostático ducha empotrada, sin llave de paso, sin parte empotrada, para art.ZB007220



ACABADOS DISPONIBLES

-  **21** 21 Cromo
-  **2F** 2F Níquel Cepillado
-  **40** 40 Negro Mate
-  **4Q** 4Q Blanco Mate

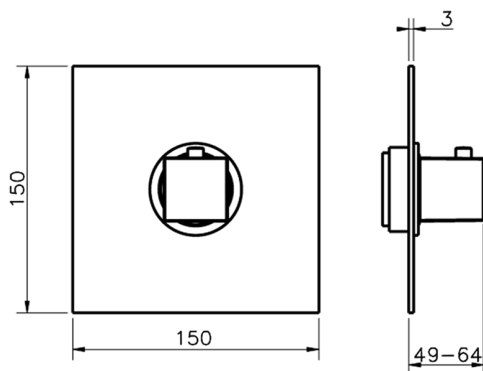

CARACTERÍSTICAS

Instalación	Empotrado
Empotrado 1	ZB007220



Termostático

El Termostático Huber es tu gestor personal del agua, ayudándote a manejar, controlar y ahorrar agua y energía.



Parte empotrada termostático ducha 3/4" EMPOTRADO_ZB007220

MODELO **ZB007220**

Parte empotrada termostático ducha 3/4", sin llave de paso, sin parte externa

ACABADOS DISPONIBLES



04 04 Sin Acabado

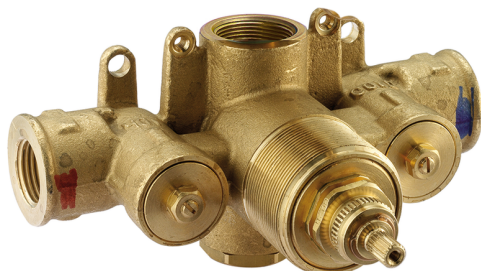

CARACTERÍSTICAS

Instalación **Empotrado**

Recambio Cartucho **23.51A.HF**

Cartucho Termostático HF

Empotrado **1**

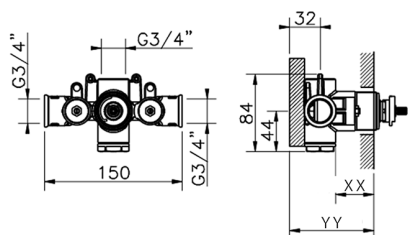

Piastra/Plate/Plaque/Platte/Placa

2-3mm: XX 25-40 YY 76-91

10mm: XX 16-31 YY 65-80



Termostático

El Termostático Huber es tu gestor personal del agua, ayudándote a manejar, controlar y ahorrar agua y energía.



2024-12-22