





Parte externa monomando lavabo de pared LEVITY_LY005511

MODELO **LY005511**

Parte externa monomando lavabo de pared, sin parte empotrada, caño L.250 mm, para art. Easy-Box ZB002450 y art. ZB025510



ACABADOS DISPONIBLES

-  **21** 21 Cromo
-  **2B** 2B Níquel Brillo
-  **2F** 2F Níquel Cepillado
-  **40** 40 Negro Mate
-  **4Q** 4Q Blanco Mate

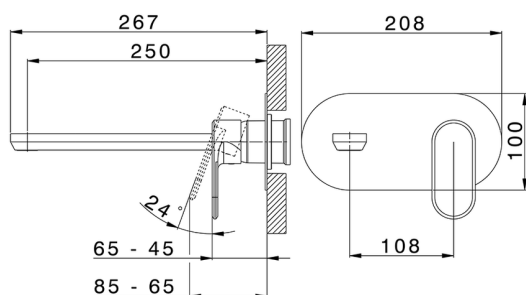

CARACTERÍSTICAS

| | |
|-------------|------------------|
| Instalación | Empotrado |
| Empotrado 1 | ZB002450 |



Parte externa monomando lavabo de pared LEVITY_LY005511

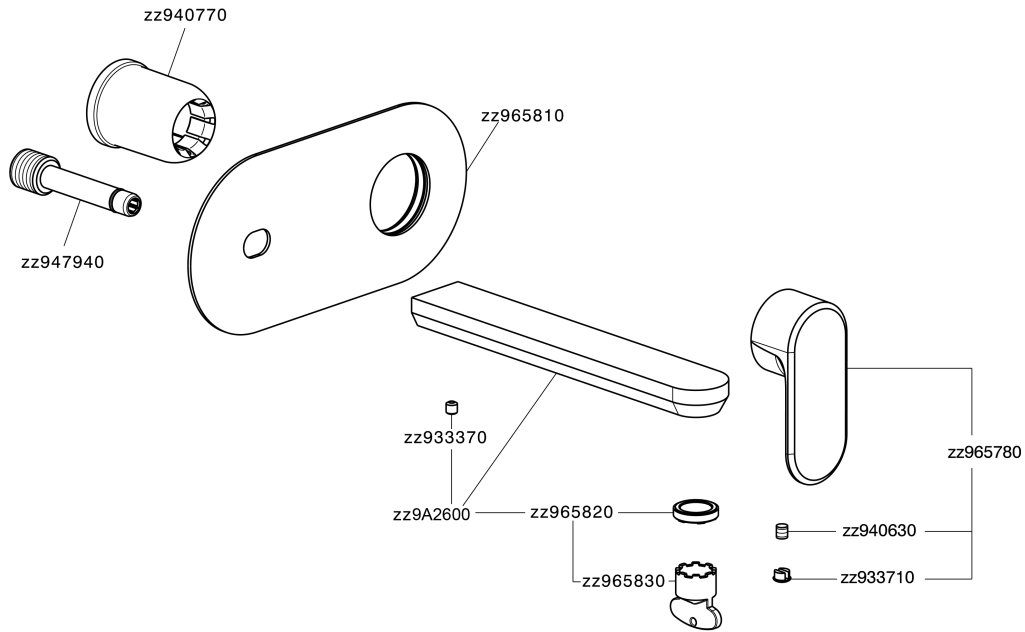

LY005511

<https://es.huberitalia.com/parte-externa-monomando-lavabo-de-pared-levity-ly005511>

Parte empotrada monomando lavabo de pared Easy-Box EMPOTRADO_ZB002450

MODELO **ZB002450**

Parte empotrada monomando lavabo de pared Easy-Box, con caja de protección, sin parte externa

ACABADOS DISPONIBLES



CARACTERÍSTICAS

| | |
|---------------------------------|-------------------|
| Instalación | Empotrado |
| Recambio Cartucho | ZZ95409000 |
| Cartucho Monomando 35 mm | |
| Empotrado | 1 |



Piastra/Plate/Plaque/Platte/Placa

2-3mm: XX 56-76

10mm: XX 48-68



DeviaStop

La tecnología Huber DeviaStop le permite ajustar el caudal de agua y dirigirla hacia la salida elegida (rociador superior, ducha de mano, etc.).



2026-06-10