

Bañera monomando con duplex NORMA_NM000093



MODELO **NM000093**

Bañera monomando con duplex, soporte duchita articulado mural, duchita Teti 3 funciones de ABS, flexible de Latón 150 cm

ACABADOS DISPONIBLES



CARACTERÍSTICAS

Recambio Cartucho **ZZ94034000**

Cartucho Monomando 35 mm

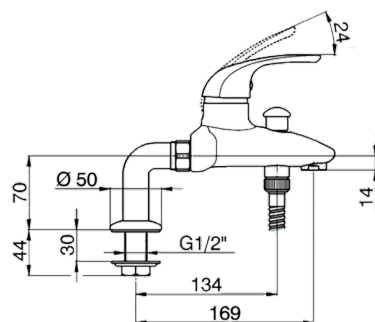
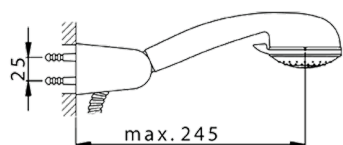

2026-06-10