

Parte externa para termostático empotrado PUSH&SHOWER_PS0G1030

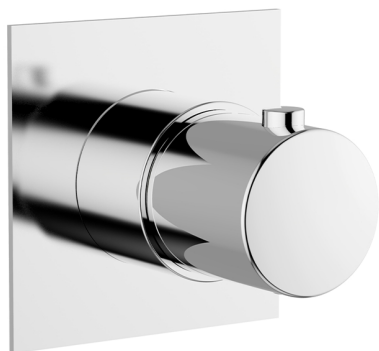

MODELO **PS0G1030**

Parte externa para termostático empotrado, sin parte empotrada, placa embellecedora cuadrada 80x80 mm, para empotrado termostático con caja de protección

ACABADOS DISPONIBLES

-  **21** 21 Cromo
-  **24** 24 Oro
-  **26** 26 Cobre Viejo
-  **2B** 2B Níquel Brillo
-  **2F** 2F Níquel Cepillado
-  **2W** 2W Oro Cepillado
-  **3W** 3W Brushed Black Titanium
-  **5G** 5G Oro Rosa
-  **40** 40 Negro Mate

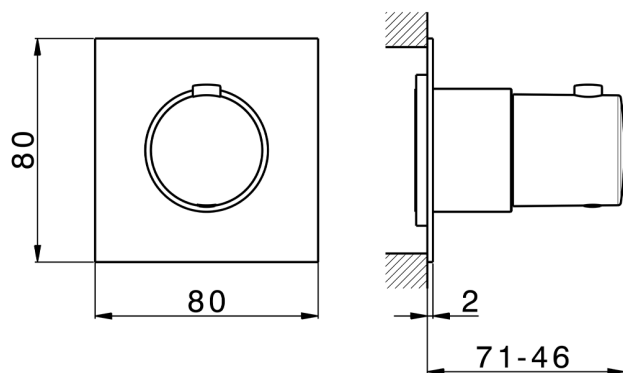

Termostático

El Termostático Huber es tu gestor personal del agua, ayudándote a manejar, controlar y ahorrar agua y energía.

CARACTERÍSTICAS

Instalación

Empotrado

Empotrado 1

ZB0G1000



Parte empotrada termostático EMPOTRADO_ZB0G1000

MODELO **ZB0G1000**

Parte empotrada termostático, sin llave de paso, con caja de protección, combinar con parte externa termostática, sin parte externa



ACABADOS DISPONIBLES

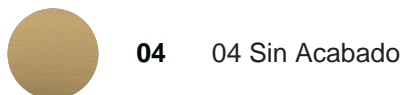

CARACTERÍSTICAS

Recambio Cartucho **22.04A.AR - ZZ97279004**

Cartucho Termostático Argo 2 (filtro lungo)

Empotrado **1**

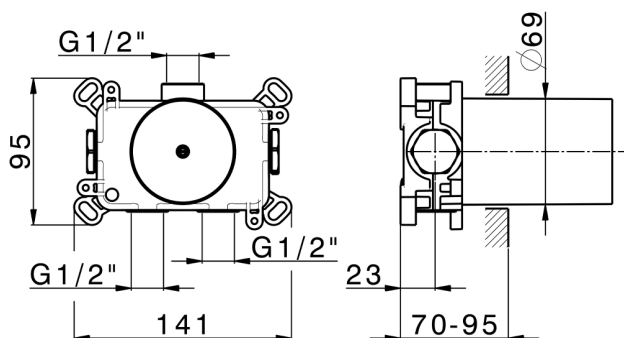

Termostático

El Termostático Huber es tu gestor personal del agua, ayudándote a manejar, controlar y ahorrar agua y energía.



2025-01-21