





Lavabo monomando DADO_DD000510



MODELO **DD000510**

Lavabo monomando, con desagüe automático
1"1/4, latiguillos acero G.3/8"

ACABADOS DISPONIBLES

-  **21** 21 Cromo
-  **2B** 2B Níquel Brillo
-  **2F** 2F Níquel Cepillado
-  **40** 40 Negro Mate
-  **4Q** 4Q Blanco Mate

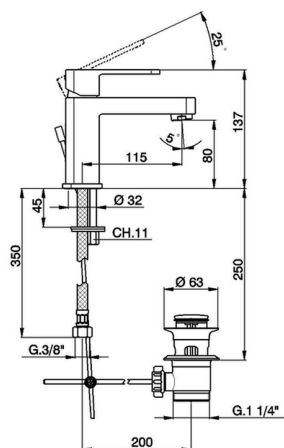

CARACTERÍSTICAS

Recambio Cartucho **ZZ94240000**

Cartucho Monomando 25 mm



Lavabo monomando DADO_DD000510

DD 00051 0

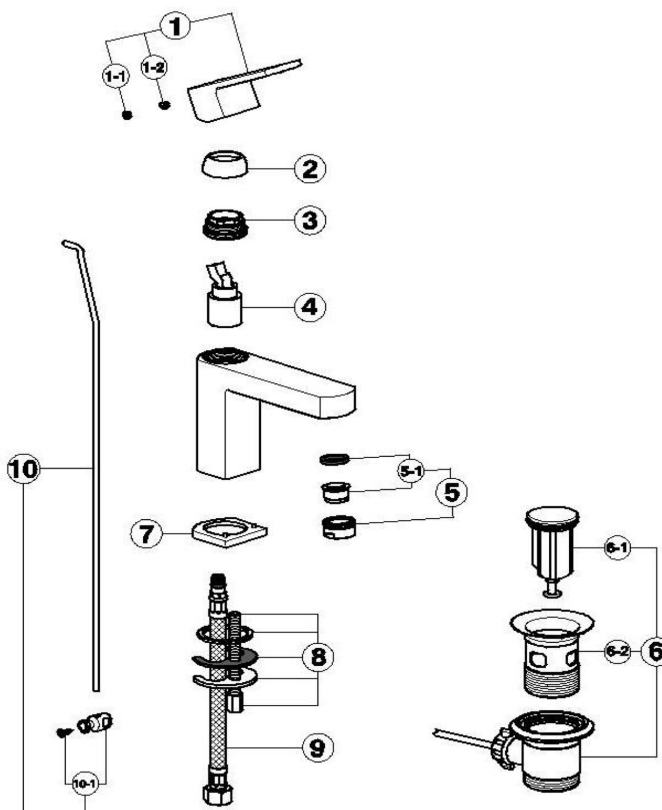
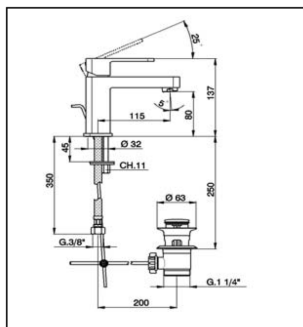

NR	DESCRIZIONE DESCRIPTION DESCRIPTION BESCHREIBUNG DESCRIPCION	N.CODICE NR.CODE CODE NO. WERSKNR. N.CÓDIGO
1	Leva monomando "DD" Lever "DD" Hebel "DD" Palanca monomando "DD" Placchetta maniglia LS Plaque cache - vis crois LS	ZZ955930
1-1	Cap for handle LS Abdeckkappe LS Griff Plaquita maneta LS Grano punta coppa inox M.5x6 Vis speciale inox M.5x6	ZZ933710
1-2	Screw-stainless steel M.5x6 Madenschraube M.5x6 Clavija con punta copa acero inox M.5x6	ZZ940630
2	Copricartuccia monomando Couvre-cartouche Escutcheon cartridge Abdeckkappe Cubre-cartucho monomando Calotta bloccaggio cartuccia Ecrou pour cartouche	ZZ955210
3	Nut for mixing valve Mutter fuer Kartusche Casquete de fijación cartucho Cartuccia monomando Cartouche mitigeurs	ZZ955220
4	Mixing valve Kartusche Cartucho monomando	ZZ942400

NR	DESCRIZIONE DESCRIPTION DESCRIPTION BESCHREIBUNG DESCRIPCION	N.CODICE NR.CODE CODE NO. WERSKNR. N.CÓDIGO
5	Aeratore M24x1 IA Cascade Mousseur M24x1 IA Cascade Mousseur M24x1 IA Cascade Perlator M24x1 IA Cascade Aireador M24x1 IA Cascade	ZZ944150
5-1	Cartuccia per aeratore M.24x1 Cascade Cartouche pour mousseur M.24x1 Cascade Mousseur cartridge M.24x1 Cascade Kartusche fuer Perlator M.24x1 Cascade Cartucho para aireador M.24x1 Cascade	ZZ933990
6	Scarico automatico 1"1/4 sabbato Vidage automatique 1"1/4 sabbato Pop up waste 1"1/4 sabbato Ablaufgarnitur 1"1/4 sabbato Desagüe automático 1"1/4 arenado	ZZ927540
6-1	Tappo completo scarico automatico 1"1/4 Bonde-vidage 1"1/4 Plug for pop up waste 1"1/4 Stopfen fuer Ablaufgarnitur kpl 1"1/4 Tapón completo columna desagüe automático 1"1	ZZ929250
6-2	Piletta per scarico automatico 1"1/4 Crépine pour vidage 1"1/4 Waste for bath drain 1"1/4 Ablauf fuer Ablaufgarnitur 1"1/4 Válvula para desagüe automático 1"1/4	ZZ929240
7	Basetta monomando "DD" Bague "DD" Assembling ring "DD" Basis "DD" Base monomando lavabo "DD"	ZZ955230

NR	DESCRIZIONE DESCRIPTION DESCRIPTION BESCHREIBUNG DESCRIPCION	N.CODICE NR.CODE CODE NO. WERSKNR. N.CÓDIGO
8	Set installazione monomando monoforo Set installation Installation set single hole Befestigungsset Juego de instalación monomando	ZZ940690
9	Flex M10x1-G3/8" L.420 Flex M10x1-G3/8" L.420 Flex M10x1-G3/8" L.420 Anschluss Schlauch M10x1-G3/8" L.420 Flexo M10x1-G3/8" L.420	ZZ954110
10	Astina scarico completa Ø 4 Tige Ø4 Rod Ø4	ZZ933400
10-1	Morsetto astina scarico automatico Jonction pour tige vidage Connection for pop-up rod Gelenkstück fuer Zugstange Abrazadera varilla desagüe automático	ZZ933430

DD000510

<https://es.huberitalia.com/lavabo-monomando-dado-dd000510>

2026-06-15